

Product development methodologies: the case of medical devices

Isa C.T. Santos

March, 2013

Thesis submitted to the Faculdade de Engenharia da Universidade do Porto for the degree of Doctor of Philosophy in Leaders for Technical Industries of the MIT – Portugal program

© 2013 Isa C.T. Santos. All rights reserved.

Supervisor:

João Manuel R. S. Tavares
Faculdade de Engenharia da Universidade do Porto

Co-supervisors:

Luís A. Rocha
Universidade do Minho

G. Scott Gazelle
Institute for Technology Assessment and Department of Radiology,
Massachusetts General Hospital, Harvard Medical School

*Para a Maria das Dores, o Manuel e a Sofia
que me ajudaram a chegar aqui.*

Para a Cristina e o que há-de vir.

*If we knew what we were doing,
it wouldn't be called research, would it?*

Albert Einstein

Abstract

In the last few years, the global financial crisis not only revealed many dramatic situations, but it also increased the awareness for the efficient use of resources in every sector of society. In spite of healthcare being considered by many a basic right, it did not escape the innumerable austerity measurements and reforms aiming to recover the economies of the countries affected by the crisis. Thus, currently all those involved in healthcare are looking for methodologies and tools that simultaneously reduce costs and increase the efficiency of both products and processes.

Medical devices are used in every stage of healthcare from diagnosis to treatment. It can be said that they are a vital part of healthcare. However, literature on them is scarce and dispersed making any optimization process burdensome. Here is presented a study on the distinctive features of medical devices and their development process. The main goal of this PhD Thesis was to understand how medical devices interact with the other components of the healthcare system (e.g. regulatory requirements and reimbursement decisions) and, with such knowledge, propose a dedicated new-product development methodology to assist the medical device industry to optimize their processes and develop relevant solutions. The proposed methodology was modeled and represented graphically to facilitate its diffusion as well as allow an easy identification of the elements driving the process and clearly delimitate the boundaries of the 'medical device system'.

The information and knowledge compiled here provides a holistic overview of the system in which medical devices are integrated and guides the development of new devices while optimizing the existing processes.

To demonstrate the applicability of the proposed methodology, the initial steps in the development of a smart stent-graft were addressed.

Keywords

Optimization, Medical devices, Distinctive features, Product development, Methodology, Graphic representation

Resumo

Nos últimos anos, a crise financeira mundial além de revelar situações dramáticas também alertou para o uso eficiente dos recursos em todos os sectores da sociedade. Apesar do acesso à saúde ser considerado por muitos como um direito básico, este não escapou às inúmeras medidas de austeridade e reformas que procuram recuperar as economias dos países afectados pela crise. Por conseguinte, actualmente todos os envolvidos no sector da saúde estão à procura de metodologias e ferramentas que ajudem simultaneamente a reduzir custos e a aumentar a eficiência tanto de produtos como de processos.

Os dispositivos médicos são utilizados em todas as fases da prestação dos cuidados de saúde desde o diagnóstico ao tratamento. Pode dizer-se que são um componente vital na saúde. No entanto, a literatura sobre o tema é escassa e dispersa tornando qualquer processo de optimização oneroso. Aqui é apresentado um estudo sobre as características diferenciadoras dos dispositivos médicos e o respectivo processo de desenvolvimento. O objetivo principal deste projeto de Doutoramento foi perceber como os dispositivos médicos interagem com os restantes componentes do sistema de saúde (por exemplo, os requisitos regulamentares e as decisões de participação) e, com esse conhecimento, propor uma metodologia de desenvolvimento de produto dedicada aos dispositivos médicos de modo a auxiliar a indústria a otimizar os seus processos e desenvolver soluções mais eficazes. A metodologia proposta foi modelada e representada graficamente de modo a facilitar a sua difusão e também permitir uma fácil identificação dos elementos que condicionam o processo assim como os limites do 'sistema do dispositivo médico'.

A informação compilada nesta Tese fornece uma visão holística do sistema onde os dispositivos médicos se integram e guia o desenvolvimento de novos dispositivos ao mesmo tempo que otimiza os processos existentes.

Para demonstrar a aplicabilidade da metodologia proposta, foram dados os passos iniciais no desenvolvimento de uma endoprótese inteligente.

Palavras-chave

Optimização, Dispositivos Médicos, Características diferenciadoras, Desenvolvimento de produto, Metodologia, Representação gráfica

Acknowledgment

I would like to thank to:

- my family for the support and encouragement;
- Ana, Cláudio, and Gustavo for everything and just because;
- my friends for being patient and helping out whenever I needed;
- my supervisors – Prof. João Manuel R. S. Tavares, Prof. Luís Rocha and Prof. Scott Gazelle – and the Thesis committee – Prof. Gustavo Dias and Prof. Jeremy Gregory;
- Prof. Richard de Neufville, Prof. Ricardo Valerdi, and the professors and staff of the Materials Systems Laboratory (MSL) for their hospitality during my visits to MIT;
- Dr. Roncon de Albuquerque and Dr. Sérgio Sampaio from Hospital São João (Porto, Portugal) for the support provided in the study of aortic aneurysms and the data collection;
- Dr. Albuquerque Matos and Dr. Ricardo Pereira from Hospitais da Universidade de Coimbra (Coimbra, Portugal) for the support provided in the data collection;
- Anabela Carvalho for the aid in the creation of adequate surveys;
- Miguel Marafuz and Ana Torres for some of the illustrations;
- Carla Monteiro for the writing embellishments;
- to the students of the Master in Industrial Design at FEUP for their valuable comments and doubts;
- those who supported me in any respect during the completion of the project.

This work was supported by the grant SFRH/BD/42967/2008 from Fundação para a Ciência e Tecnologia (FCT), in Portugal, and partially supported by the project “SenseCardioHealth: New technological solutions for smart cardiovascular medical devices” - MIT-Pt/EDAM-EMD/0007/2008, sponsored by FEDER through COMPETE and national funds through FCT.

Contents

1	Introduction.....	1
1.1	Motivation.....	3
1.2	Research questions.....	5
1.3	Thesis structure.....	6
1.4	Contributions.....	7
2	Peculiarities of medical devices.....	9
2.1	Introduction.....	11
2.2	Definition of ‘medical device’.....	11
2.3	Regulatory framework.....	15
2.4	Classification.....	18
2.5	Pathway to market.....	22
2.5.1	Europe.....	23
2.5.2	USA.....	25
2.6	Post-market activities.....	28
2.7	Recall.....	28
2.8	Market.....	30
2.9	Adoption factors for medical devices.....	32
2.10	Pricing.....	35
2.11	Reimbursement.....	36
2.12	Ethics.....	38
2.13	Product development.....	40
2.14	Redesign.....	42
2.15	Medical device users.....	42
2.16	Medical devices vs Drugs.....	44
2.17	Chapter takeaways.....	46
3	Methodologies for the development of medical devices.....	49
3.1	Introduction.....	51
3.2	Process modeling.....	51
3.3	Modeling of the product development process.....	52

3.4	Modeling of the medical devices development process.....	56
3.5	Chapter takeaways.....	64
4	New methodology for the development of medical devices.....	65
4.1	Introduction	67
4.2	Commercial flops and recalls	67
4.3	Evolution of the proposed methodology for the development of medical devices	70
4.4	New methodology for the development of medical devices.....	73
4.4.1	Ideation	73
4.4.2	Concept development	75
4.4.3	Design.....	85
4.4.4	Regulatory approval and clearance.....	89
4.4.5	Post-market activities.....	89
4.5	Chapter takeaways.....	90
5	Study case: Smart stent-graft.....	91
5.1	Introduction.....	93
5.2	Background.....	93
5.3	Before the new development methodology	95
5.4	After the new development methodology.....	100
5.5	Chapter takeaways.....	100
6	Conclusions and future work.....	103
6.1	Conclusions.....	105
6.2	Future work	106
	Bibliography	107

List of figures

Figure 1.1: World population evolution (from (Population Division 2011)).	3
Figure 1.2: Overview of the components of the healthcare system (from (Rouse 2008)).	4
Figure 1.3: Total expenditure on health as a percentage of the gross domestic product in 2010 (from (WHO 2012a)).	5
Figure 1.4: Topics addressed in this thesis (shaded boxes) and the topics identified for future research. (MD – medical device).	6
Figure 2.1: Organization of the Food and Drug Administration (FDA) in the USA.	15
Figure 2.2: Example of the authorized representative logo.	18
Figure 2.3: Components of a typical regulatory framework (adapted from (WHO 2010)).	19
Figure 2.4: Multiple classifications for medical devices.	20
Figure 2.5: Example of the CE mark; “xxxx” represents the four digit number attributed to the notified body.	23
Figure 2.6: Flowchart with the European path to market.	25
Figure 2.7: Flowchart with the USA path to market SE – substantially equivalent; NSE – not substantially equivalent.	27
Figure 2.8: Supply chain of medical devices. The recall depth refers to the level of distribution from which a device is recalled (wholesale, retailer or consumer).	29
Figure 2.9: The diffusion process and description of technology adopters (adapted from (Rogers 1995)).	33
Figure 2.10: Factors influencing the adoption of medical devices.	35
Figure 2.11: Players in the development of medical devices, their interest and interactions; conflicts of interest may occur when there are adverse interests of both parties.	39
Figure 2.12: Typical lifecycle of a medical device (adapted from (AAMI Association for the Advancement of Medical Instrumentation 2009)).	41
Figure 2.13: Typical lifecycle of a medical technology (adapted from (Office of Technology Assessment 1982)).	42
Figure 2.14: Common reasons to redesign a product.	43
Figure 2.15: Medical device users (adapted from (Shah and Robinson 2008)) and their main interactions with the devices.	44
Figure 2.16: Typical product life cycle curve for medical devices and drugs.	45
Figure 3.1: Representation of the valley of death and some of reasons for falling on it.	53
Figure 3.2: Conceptual representations of the product development process: on the right, the	

model suggested by Barclay et al. (Barclay et al. 1994), in the center, the one suggested by Ulrich et al. (Ulrich and Eppinger 2011) and, on the left, the model presented by Barry Boehm (Boehm 1988).
..... 54

Figure 3.3: The new-product development presented by Kotler et al. (Kotler and Keller 2012). ... 54

Figure 3.4: The stage-gate model presented by Cooper et al. (Cooper 2008; Cooper 1990). 54

Figure 3.5: The house of quality (HoQ). 55

Figure 3.6: Value stream map of a product development process (adapted from (Mcmanus 2005)).
..... 55

Figure 3.7: Methodological framework for literature searching and retrieval of relevant publications on the development process of medical devices. 56

Figure 3.8: Evolution of the number of publications on the development process of medical devices..... 61

Figure 3.9: Richard C. Fries’s representation of the medical device development process (adapted from (Fries 2006; Fries 2001)). 61

Figure 3.10: Model example for production planning process from Medina et al. (Medina et al. 2012)..... 62

Figure 3.11: Representation of the medical device development process presented by Pietzsch et al. (Pietzsch et al. 2009)..... 63

Figure 4.1: The Vanguard stent-graft (from (Kaufman et al. 1999)). 69

Figure 4.2: On the left, the ERBEJET® 2 from ERBE Elektromedizin GmbH; on the right, selective tissue dissection (from(Rau et al. 2008))..... 69

Figure 4.3: Rotating hinge knee prosthesis (adapted from (Guenoun et al. 2009)). 70

Figure 4.4: Evolution of the proposed methodology for the development of medical devices. 71

Figure 4.5: Number of respondents to the first content validation..... 72

Figure 4.6: The development process of medical devices. 73

Figure 4.7: On the left, the typical curve cost– development time; on the right, the proposed curve for the development of medical devices..... 74

Figure 4.8: The ideation stage. 76

Figure 4.9: The concept development stage..... 78

Figure 4.10: The voice of the customer sub process..... 79

Figure 4.11: The management of the intellectual property sub process..... 81

Figure 4.12: Overview of the technology readiness level (TRL) scale. TRL is a measure to assess the maturity of evolving technologies (materials, components, devices, etc.) prior to incorporating that technology into a system or subsystem (adapted from (Mankins 2009))..... 84

Figure 4.13: Overview of the manufacturing readiness level (MRL) scale (adapted from (DoD 2011)).	84
Figure 4.14: The design stage.	86
Figure 4.15: The product design sub process.	87
Figure 4.16: The manufacture design sub process.	87
Figure 4.17: Different prototyping stages.	88
Figure 4.18: The hazard analysis sub process.	89
Figure 5.1: Representation of a normal aorta and an abdominal aortic aneurysm (AAA or triple A).	93
Figure 5.2: Management of aortic aneurysms; circles represent events while rectangles represent actions.	94
Figure 5.3: Planning of the development of the smart stent-graft.	95
Figure 5.4: Criteria considered during the selection of a stent-graft and their relevance. <i>Question:</i> When selecting a stent-graft, what is the relevance of the following factors?; <i>Total answers:</i> 65.....	96
Figure 5.5: Valuation of the stent-graft's characteristics. <i>Question:</i> What do you value in a stent-graft?; <i>Total answers:</i> 65.....	97
Figure 5.6: Description of the EVAR follow-up protocol. <i>Question:</i> How would you describe the exam process?; <i>Total answers:</i> 65.	97
Figure 5.7: Difficulty in the detection of complications. <i>Question:</i> How would you classify the identification of the following problems?; <i>Total answers:</i> 65.	98
Figure 5.8: Information provided by a smart stent-graft. <i>Question:</i> Which information would you like to obtain from a stent-graft?; <i>Total answers:</i> 65.	98
Figure 5.9: Hospitals contacted to administer the surveys to patients and the number of responses obtained.	99
Figure 5.10: The adapted ideation phase.	100

List of tables

Table 2.1: Medical device definition in Europe, USA and GHTF.	12
Table 2.2: Definition of borderline and combination product.....	13
Table 2.3: Examples of medical devices according to the European and USA definition.	14
Table 2.4: List of the European directives regulating medical devices.	16
Table 2.5: Examples of standards and regulations that medical devices must comply with.....	18
Table 2.6: Medical device’s risk categorization and regulatory control in Europe, USA and GHTF. 20	
Table 2.7: Device categories currently established by GMDN.....	22
Table 2.8: FDA’s classification of the medical device recall (adapted from (FDA 2012d)).	30
Table 2.9: Types of economic analyses and measurement units.....	34
Table 2.10: Organizations involved in the reimbursement process in the 8 countries with highest health expenditure in 2009 (the list is not exhaustive).....	37
Table 2.11: Players in the development of medical devices and their roles in potential conflicts of interest (adapted from (Holmes et al. 2004)).	39
Table 3.1: Process modeling languages.	52
Table 3.2: Documents included in the literature review; model’s possible use and modeling language adopted.....	57
Table 4.1: Causes for commercial failure of medical devices.	68
Table 4.2: Basic BPMN modeling elements (adapted from (Briol 2008)).	72
Table 4.3: Business analysis techniques (adapted from (Cadle et al. 2010)).....	75
Table 4.4: Topics that should be addressed in the study on the medical condition (adapted from (Zenios et al. 2010)).....	77
Table 4.5: Tools for capturing the voice of the customer (adapted from (Martin et al. 2006; National Patient Safety Agency 2010)).	80
Table 4.6: Tools for concept generation (adapted from (Miller 2012; Silverstein et al. 2008)).	81
Table 5.1: Usual complications involving stent-grafts (adapted from (Katzen and MacLean 2006)).	95
Table 5.2: Mission statement regarding the development of the smart stent-graft.....	96
Table 5.3: Requirements for the smart stent-graft.....	99
Table 5.4: Project’s mission statement.	100

Acronyms

510(k) – Section of the Food, Drug, and Cosmetic Act that deals with premarket notification

AAA or triple A – Abdominal Aortic Aneurysm

AAMI – Association for the Advancement of Medical Instrumentation

AdvaMed – Advanced Medical Technology Association

AMA – American Medical Association

BPMN – Business Process Model and Notation

CA – Competent Authority

CBA – Cost - Benefit Analysis

CDRH – Center for Devices & Radiological Health

CE – of the French ‘Conformité Européenne’ meaning ‘European Conformity’

CEA – Cost - Effectiveness Analysis

CEO – Chief Executive Officer

CFR – Code of Federal Regulations

CGMP – Current Good Manufacturing Practice

CPT – Current Procedural Terminology

CTA – Computed Tomography Angiography

CUA – Cost – Utility Analysis

DHF – Design History File

DPMD – Development Process of Medical Devices

DRGs – Diagnosis Related Groups

EFTA – European Free Trade Association

ERP – Enterprise Resource Planning system

EU – European Union

EV – Expected Value

EVAR – EndoVascular Aneurysm Repair

FD&C – Food, Drug & Cosmetic

FDA – Food and Drug Administration

FDAMA – FDA Modernization Act

FMEA – Failure Modes and Effects Analysis

FMECA – Failure Modes Effects and Criticality Analysis

FSCA – Field Safety Corrective Action

FSN – Field Safety Notice

FTA – Fault Tree Analysis

GHTF – Global Harmonization Task Force

GMDN – Global Medical Devices Nomenclature

HCPCS – Healthcare Common Procedural Coding System

HDE – Human Device Exemption

HoQ – House of Quality

HTA – Health Technology Assessment

ICD – International Classification of Diseases

IDE – Investigational Device Exemption

IEC – International Electrotechnical Commission

IMDRF – International Medical Device Regulators' Forum

ISO – International Organization for Standardization

IVD – *In Vitro* Diagnostic medical device

MAUDE – Manufacturer and User Facility Device Experience Database

MDR – Medical Device Reporting

MEDDEV – Commission guideline relating to the directives of medical devices

MEDEC – Canada's Medical Device Technology Companies

mm Hg – Millimeter of mercury

MOST (analysis) – Mission, Objectives, Strategy, Tactics

NANDO – New Approach Notified and Designated Organization

NB – Notified Bodies

NHS – National Health Service

NIC – National Innovation Centre

NICE – National Institute for Health and Clinical Excellence

NSE – Not substantially equivalent

PHA – Preliminary Hazard Analysis

PIP – Poly Implant Prosthèse

PMA – Premarket approval

QALYs – Quality - Adjusted Life Years

QFD – Quality Function Deployment

QSR – Quality System Regulation

R&D – Research and development

SE – Substantially equivalent

SWOT (analysis) – Strengths, Weaknesses, Opportunities, and Threats

UK – United Kingdom

UML – Unified modeling language

USA – United States of America

WHO – World Health Organization

WIPO – World International Patent Office

WMS – Warehouse Management System

WTP – Willingness to Pay

1 Introduction

1.1 Motivation

The burst of the ‘housing bubble’, which peaked in 2006, was the beginning of the 2008 financial crisis that many consider to be the worst financial crisis since the Great Depression of the 1930s. Since then, large financial institutions collapsed, key businesses failed, Europe immersed in a sovereign-debt crisis, and the words ‘austerity’ and ‘cut’ became the most repeated ones in the news. It is certain that these events exposed many dramatic situations, but they also put in the spotlight the efficient use of resources in every sector of society.

In spite of the ‘right to health’ being recognized in the Universal Declaration of Human Rights and being included in the Constitution of some countries (e.g. Portugal and France), healthcare did not escape the many reforms and austerity measures aiming to recover the economies of the countries affected by the crisis. Nonetheless, prior to these events, healthcare was already under financial pressure due to, on the one hand, the growth of a middle class that is price sensitive but demands quality healthcare services and, on the other hand, the population’s alarming aging levels (Figure 1.1) and the consequent demand for more and better healthcare services and their costs. Overall, it can be said that healthcare was changing and the crisis just stressed the importance of healthcare providers being able to adapt, optimize their processes, and develop solutions that really matter demonstrating the value of both their products and services.

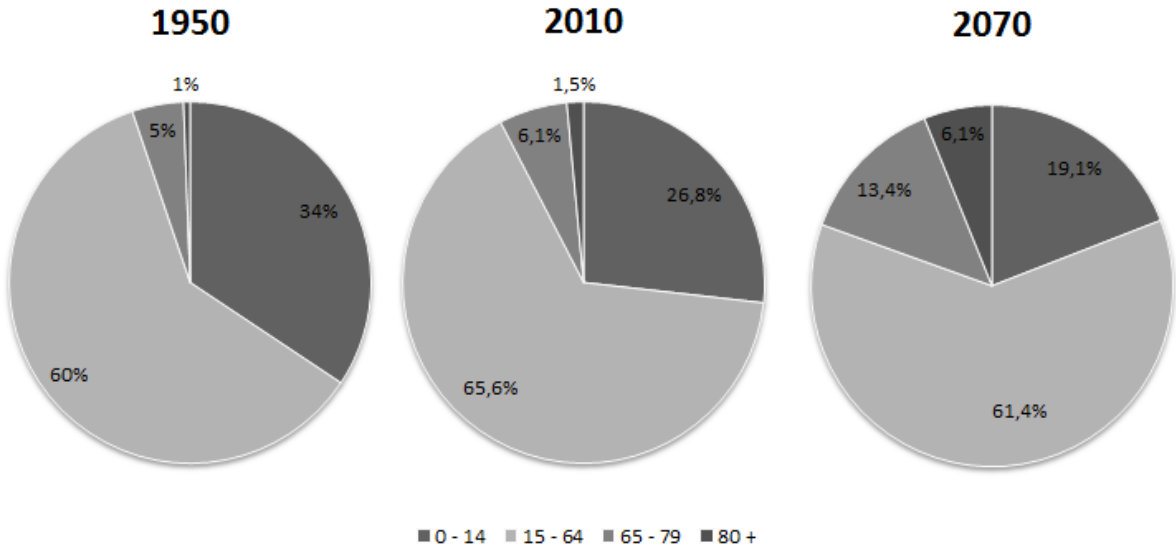

Figure 1.1: World population evolution (from (Population Division 2011)).

Healthcare includes all the goods and services designed to promote health, and it can be considered a complex system that integrates and combines people, processes, and products (Tien and Goldschmidt-Clermont 2009). Figure 1.2 shows healthcare’s multiple constituents and some of their relations. In order to increase efficiency and reduce costs in this system it is not enough to decompose it, analyze and improve each one of its components, and recompose the optimized parts;

it is essential to understand the components' interactions as well. By studying a system as a whole, one understands the dynamics of the relations between the components allowing to make better decisions and avoid negative unintended consequences.

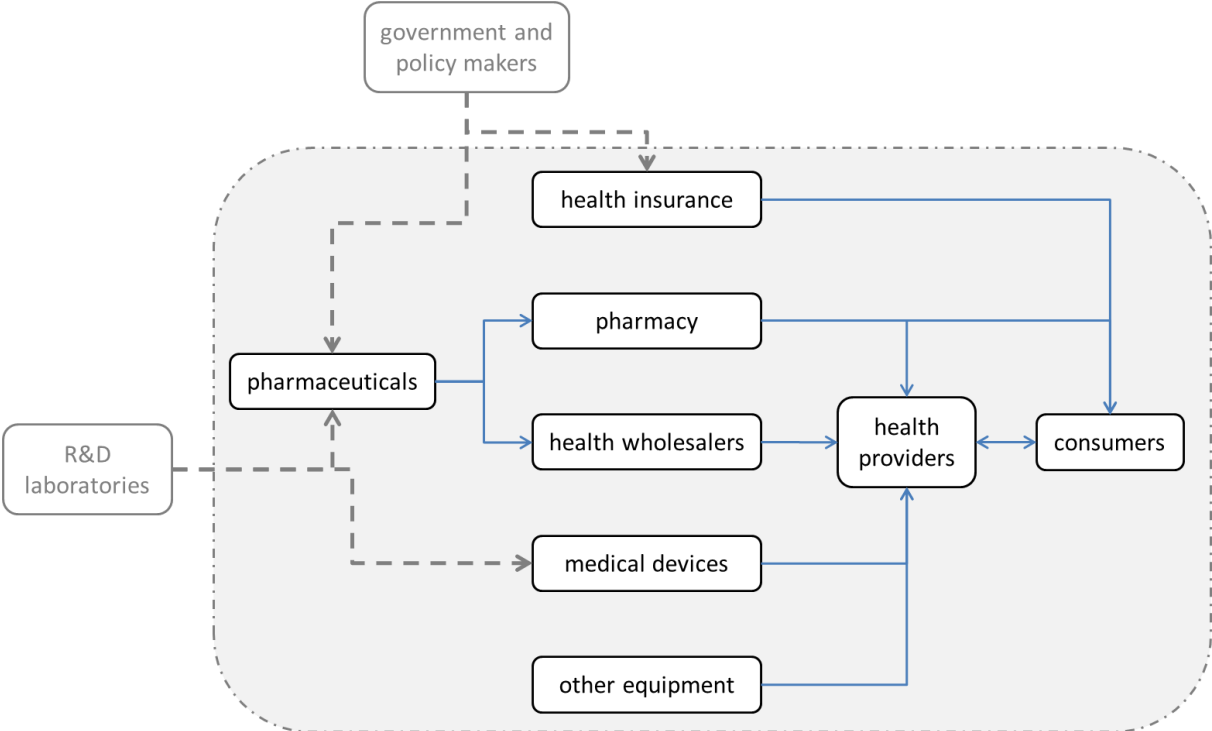

Figure 1.2: Overview of the components of the healthcare system (from (Rouse 2008)).

Medical devices refer to any apparatus, software, material, or other similar or related item intended to be used in diagnosis, prevention, monitoring, treatment, or alleviation of a disease. Hence, they are present in every stage of healthcare and have the power to change the way it is organized, paid for, and delivered. For instance, the introduction of rapid diagnostic tests allowed diagnosis being made in low-resource settings by minimally trained health personnel and permitted quick screening of potentially affected populations reducing the risk of patients getting sicker before a correct diagnosis being made and the need for multiple visits to receive the results. In addition, they also improved the specificity of the diagnosis impacting the chances of the patients receiving treatment and preventing over-prescription of antibiotics.

Medical devices exist since pre-historic times and there was a point in history in which barbers were surgeons and the local blacksmith made the tools. Even though healthcare and the associated professions evolved, the development of medical devices remained an experimental and messy business. Currently, in spite of representing only around 6% of the total health expenditure in Europe and around 5% in the USA and Japan (Pammolli et al. 2005) (Figure 1.3), medical devices are a growing and challenging industry that resorts to increasingly complex technologies and has to overcome tough quality and regulatory hurdles.

Until recently, companies able to develop and produce devices that meet both the quality and regulatory requirements could sell their products at prices that made the effort worthwhile. However, the economic crisis associated with the appearance of new players from China and India known for low-cost designs is changing the market. Like other industries before them, e.g.

automotive, consumer electronics and telecommunications, the medical device sector is searching for novel ways to maintain competitiveness and for that they are searching for new tools as well as a new way of thinking about medical device design.

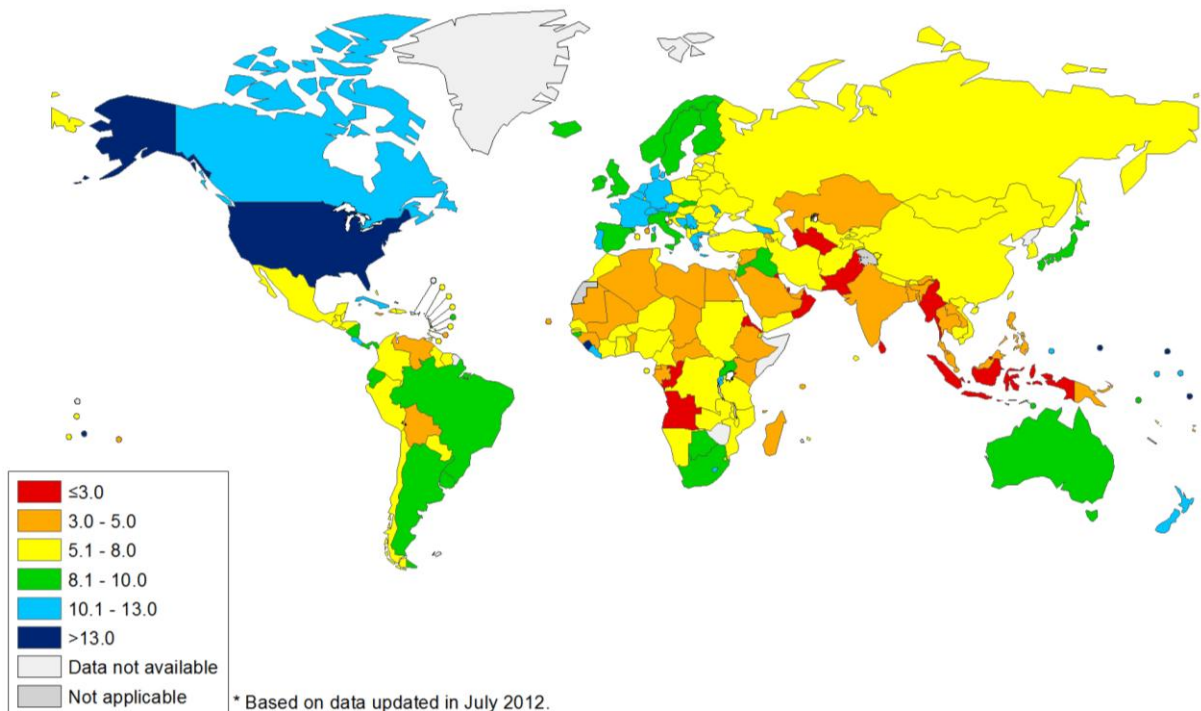

Figure 1.3: Total expenditure on health as a percentage of the gross domestic product in 2010 (from (WHO 2012a)).

A deep knowledge of the multiple components of the medical devices' sector and their interrelations is essential to support the development of tools that aid the design of cheaper and more efficient devices. However, currently such knowledge is insufficient and not easily found. Here we intend to fill such gap by presenting a study on the distinctive features of medical devices and their development process and thus delimitate the boundaries of the 'medical device system'. This work aims to gather the information scattered in books, few scientific papers, webpages, and grey literature and be a starting point of further research in this area.

Besides the peculiarities of medical devices, it is suggested a product development methodology dedicated to medical devices. The process described draws a roadmap to transform an idea into an efficient medical device that is able to meet not only the regulatory and quality requirements, but also the customers' expectations. Special attention was given to the representation of the methodology so that scientists, healthcare professionals, engineers and students can easily initiate themselves in the development of innovative devices to help people.

1.2 Research questions

The main goal of this Thesis was to present a methodology able to support the development of novel medical devices. The secondary objective was to provide a better comprehension on the

medical device sector, that is, to identify the players and understand how they interact and influence the development of novel devices.

The research questions that were answered by this study can be stated as follows:

- What are the features that are common to medical devices but distinguish them from other products?
- Which factors influence the development of a novel medical device?
- Are the current product development methodologies able to accommodate the medical devices' characteristics?

The answers to these questions were found resorting mainly to qualitative techniques; key concepts were clarified after extensive literature reviews and document analyses. These techniques also allowed inferring the proposed medical device methodology.

1.3 Thesis structure

The research presented here covers different aspects related with the development process of a novel medical device. Figure 1.4 correlates the major topics addressed and shows areas that were identified to be addressed in the future.

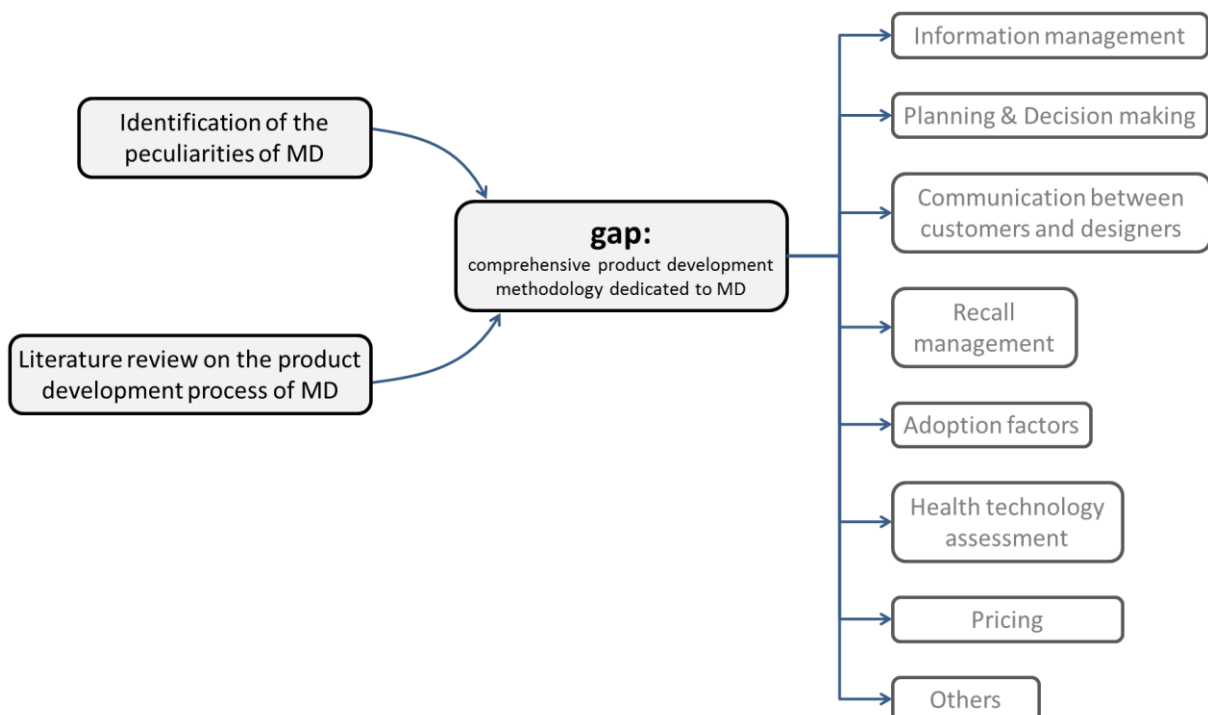

Figure 1.4: Topics addressed in this thesis (shaded boxes) and the topics identified for future research. (MD – medical device)

This Thesis is organized into 6 chapters, including the introduction and conclusions. Chapter 2 identifies the characteristics that are common to medical devices but distinguish them from other products. The peculiarities identified suggest that the development process of medical devices is

complex and may benefit from a dedicated methodology.

Chapter 3 reviews the literature available on the representation of the new-product development process and the existing methodologies dedicated to medical devices. The state of the art shows that there is a gap in the overall understanding of the development process of medical devices.

Chapter 4 proposes a dedicated methodology for the development of medical devices driven by the peculiarities of medical devices identified in chapter 2 and the gap identified in chapter 3. Although the proposed methodology is prescriptive, it should be considered as a guideline and be adapted to the device and the design team.

Chapter 5 compares a commonly accepted new-product development methodology with the proposed one. Although no device was obtained, this example suggests that the proposed methodology can increase the efficiency of the development process.

Chapter 6 points out the major conclusions of this research and proposes areas for further research.

1.4 Contributions

The main contributions of this PhD project are the identification and description of the distinctive features of medical devices and the proposal of a dedicated new-product development methodology.

To accomplish those contributions, the information on medical devices, that is typically scattered, was collected, organized, and compiled. In addition, the product development methodologies concerning medical devices were identified and reviewed.

In the studies carried out, especial attention was given to the information concerning the European reality of the medical devices. The European market and regulatory framework were analyzed and compared with the American reality, the World's largest market.

The drawbacks of the traditional product development methodologies led to the development of a new methodology which was modeled and represented graphically to facilitate its diffusion as well as allow an easy identification of the elements driving the process.

Definitions of terms, such as “commercial success” and “commercial flop”, were presented.

The proposed methodology was applied in the development of a smart stent-graft. Although no prototype was obtained, relevant information on its desired characteristics was collected and analyzed.

2 Peculiarities of medical devices

2.1 Introduction

The surgical instruments used in cranial trepanations found at Neolithic excavation sites and the proofs of use of acupuncture needles in prehistoric Peruvian mummies demonstrate the existence of medical devices in prehistoric times (Gad and McCord 2008). During the subsequent centuries many devices, such as dilators and tweezers, were created, but it was only during the 19th century that the modern medical technology began with the invention of the ophthalmoscope and the laryngoscope, and later on, with the discovery of X-rays (WHO 2010).

According to the World Health Organization (WHO), currently there are around 1.5 million different medical devices (WHO Media centre 2010). At first glance, this number is overwhelming but, considering that the term ‘medical device’ includes apparatuses ranging from bandages to baby incubators, pacemakers or engineered tissues, the figure becomes reasonable.

The mixture of products is not the only explanation for the complexity and uniqueness of the medical device sector. Other peculiarities, such as the variety of definitions for the expression ‘medical device’ along with the multiplicity of regulations and standards that devices must comply with and the existence of motley agencies that evaluate devices before commercialization, contribute to it. Following, the characteristics that are common to medical devices but distinguish them from other products are identified and described; these characteristics include topics such as the regulatory framework, classification, pathway to market, adoption factors, pricing, and development process of the medical devices.

This chapter contains work and results of the article ‘Medical devices specificities: opportunities for a dedicated product development methodology’ by Isa C.T. Santos, G. Scott Gazelle, Luís Rocha, and João Manuel R. S. Tavares published in the May 2012 issue of the journal *Expert Review of Medical Devices*. It also contains work and results of the article ‘Additional peculiarities of medical devices that should be considered in their development process’ by Isa C.T. Santos and João Manuel R. S. Tavares published in the May 2013 issue of the journal *Expert Review of Medical Devices*.

2.2 Definition of ‘medical device’

In 1992, a voluntary group of representatives from national medical device regulatory authorities and the regulated industry formed the Global Harmonization Task Force (GHTF) with the objective to achieve greater uniformity between national medical device regulatory systems (GHTF 2011). Although several documents concerning medical devices were created, a consensus was not reached. In fact, at the beginning of 2012, the media announced its extinction and the formation of a new organization with similar objectives – the International Medical Device Regulators' Forum (IMDRF) (International Medical Device Regulators Forum).

Currently, various definitions for the expression ‘medical device’ coexist (Table 2.1). In the United States of America (USA), it appears in section 201(h) of the Food Drug & Cosmetic (FD&C) Act, while in Europe, it is given by the Medical Devices Directive 93/42/EEC which is explained in the guidance document MEDDEV 2.1 from April 1994. Smaller countries, such as Japan, adopted definitions similar to the one under GHTF guidance. Overall, ‘medical device’ refers to any apparatus, software, material, or other similar or related item intended to be used in the diagnosis, prevention, monitoring, treatment, or alleviation of a disease in which the term ‘disease’ encompasses all unfavorable health changes, including injuries and mental health.

Table 2.1: Medical device definition in Europe, USA and GHTF.

System	Definition
EU [§]	<p>Any instrument, appliance, apparatus, material or other article, whether used alone or in combination, including the software necessary for its proper application, intended by the manufacturer to be used for human beings for the purpose of:</p> <ul style="list-style-type: none"> – diagnosis, prevention, monitoring, treatment or alleviation of disease; – diagnosis, monitoring, alleviation of or compensation for an injury or handicap; – investigation, replacement or modification of the anatomy or of physiological process; – control of conception; <p>and which does not achieve its principal intended action in or on the human body by pharmacological, immunological or metabolic means, but that may be assisted in its function by such means.</p>
USA [¥]	<p>An instrument, apparatus, implement, machine, contrivance, implant, in vitro reagent, or other similar or related article, including a component part, or accessory which is:</p> <ul style="list-style-type: none"> – recognized in the official National Formulary, or the United States Pharmacopoeia ^{††}, or any supplement to them, – intended for use in the diagnosis of disease or other conditions, or in the cure, mitigation, treatment, or prevention of disease, in man or other animals, or – intended to affect the structure or any function of the body of man or other animals, and which does not achieve any of its primary intended purposes through chemical action within or on the body of man or other animals and that is not dependent upon being metabolized for the achievement of any of its primary intended purposes.
GHTF ^{‡‡}	<p>Any instrument, apparatus, implement, machine, appliance, implant, in vitro reagent, software, material or other similar or related article:</p> <p>a) intended by the manufacturer to be used, alone or in combination, for human beings for one or more of the specific purpose(s) of:</p> <ul style="list-style-type: none"> – diagnosis, prevention, monitoring, treatment or alleviation of disease, – diagnosis, monitoring, treatment, alleviation of or compensation for an injury, – investigation, replacement, modification, or support of the anatomy or of a physiological process, – supporting or sustaining life, – control of conception, – disinfection of medical devices, – providing information for medical or diagnostic purposes by means of in vitro examination of specimens derived from the human body; <p>and</p> <p>b) which does not achieve its primary intended action in or on the human body by pharmacological, immunological or metabolic means, but that may be assisted in its intended function by such means.</p>

[§] In Medical Devices Directive 93/42/EEC ; [¥] In section 201(h) of the Food Drug & Cosmetic Act

^{††} The United States Pharmacopoeia–National Formulary (USP–NF) is a book of public pharmacopeial standards. It contains standards for medicines, dosage forms, drug substances, excipients, medical devices, and dietary supplements.

^{‡‡} In GHTF proposed document SG1(PD)/N071R04 - Definition of the Term ‘Medical Device’ posted in March 28, 2011

The three definitions presented in Table 2.1 have in common the fact of covering a wide range of products. Although the differences between them appear to be subtle, they impact the device's lifecycle with repercussions to manufacturers, namely the requirements that the products must comply with. For example, as in the USA's definition the word *software* is omitted, often producers and distributors are unaware that the Food and Drug Administration (FDA) also regulates these products making them subject to significant civil and criminal liability for noncompliance (Gamerman 1992).

According to the GHTF and the European definitions, manufacturers define the device's intended use. This means that raw materials are not considered medical devices, and legislation is only valid when the devices are supplied to the public. Furthermore, the principal intended action declared by the manufacturer defines the rubric under which the device is included defining the legislation to be complied with. For instance, dental floss is a toiletry product but if its manufacturer makes a medical claim such as 'cure gum infections', it will be considered a medical device.

The phrasing regarding the medical device's 'primary intended action/purpose' is currently responsible for the increasing number of products that are in the borderline between devices and drugs, e.g. implantable infusion pumps, drug-eluting stents, and single-use syringes pre-filled with medicine. These products are called in Europe 'borderline products' and 'combination products' in the USA (Table 2.2), and have peculiarities of their own that should be studied separately (Couto et al. 2012).

Table 2.2: Definition of borderline and combination product.

Borderline product [§]	<p>Borderline cases are considered to be those cases where it is not clear from the outset, whether a given product is a medical device, an in vitro diagnostic medical device, an active implantable medical device or not. Alternatively, borderline cases are those cases where the product falls within the definition of a medical device but is excluded from the Directives by their scope. Where a given product does not fall within the definition of medical device or is excluded by the scope of the Directives, another Community and/or national legislation may be applicable.</p>
Combination product [¥]	<p>(1) A product comprised of two or more regulated components, i.e., drug/device, biologic/device, drug/biologic, or drug/device/biologic, that are physically, chemically, or otherwise combined or mixed and produced as a single entity;</p> <p>(2) Two or more separate products packaged together in a single package or as a unit and comprised of drug and device products, device and biological products, or biological and drug products;</p> <p>(3) A drug, device, or biological product packaged separately that according to its investigational plan or proposed labeling is intended for use only with an approved individually specified drug, device, or biological product where both are required to achieve the intended use, indication, or effect and where upon approval of the proposed product the labeling of the approved product would need to be changed, e.g., to reflect a change in intended use, dosage form, strength, route of administration, or significant change in dose; or</p> <p>(4) Any investigational drug, device, or biological product packaged separately that according to its proposed labeling is for use only with another individually specified investigational drug, device, or biological product where both are required to achieve the intended use, indication, or effect.</p>

[§] In Manual on borderline and classification in the community Regulatory framework for medical devices Version 1.13 (10-2012); [¥] In 21 CFR 3.2(e)

In the USA, medical devices are intended to be used ‘in man or other animals’; this means that veterinary devices are considered medical devices even though they are under a different jurisdiction from the devices for human use.

In Europe, to determine if a product is a medical device, one has to interpret the definition. In the USA, one has to identify the product’s components and then search the relevant terms in the Product Classification database available in the FDA’s web page (FDA 2012a). For example, glasses; in Europe, according to their intended function, they either are personal protective equipment (sunglasses or protective glasses) or medical devices (prescription glasses). In the USA, searching the Product Classification database, there is no match for the term ‘glasses’; however, the database contains the terms ‘lens’ and ‘frame’, the two components of glasses.

Table 2.3 presents examples of the multiple interpretations of the expression ‘medical device’. However, leeches are an extreme and bizarre example. *Hirudo medicinalis* (medicinal leeches) are blood-sucking aquatic animals that live in fresh water and have been used for clinical bloodletting for thousands of years. Since 2004, FDA considers them a medical device for mechanical suction of blood, even though a regulatory class has not been given (FDA 2011a). In Europe, they are either considered an animal (e.g. Portugal and France) or a drug (e.g. Germany); they are considered a drug because the ‘principal intended action’ is the release of a drug during the blood suction.

Table 2.3: Examples of medical devices according to the European and USA definition.

Product	Usage	Type of product
Cochlear implant	Provide a sense of sound to a person who is deaf or severely hard of hearing	<i>Europe:</i> active implantable medical device <i>USA:</i> medical device
Condom	Barrier device to reduce the probability of spreading sexually transmitted diseases and pregnancy	Medical device
Implantable cardioverter-defibrillator (ICD)	Detect fatal cardiac arrhythmia and correct it by delivering a jolt of electricity	<i>Europe:</i> active implantable medical device <i>USA:</i> medical device
Intrauterine device with progestogen	Long-acting reversible hormonal contraceptive device that is placed in the uterus	<i>Europe:</i> medicine (the principal intended action is to prevent pregnancy) <i>USA:</i> medical device
Intrauterine device releasing progestogen	Long-acting reversible hormonal contraceptive device that is placed in the uterus	<i>Europe:</i> device for the administration of medicines (the principal intended action is to deliver medicine) <i>USA:</i> medical device
Nebulizer	Device used to administer medication in the form of a mist inhaled into the lungs	<i>Europe:</i> device for the administration of medicines <i>USA:</i> medical device
Specimen receptacle	Containment and preservation of specimens derived from the human body for the purpose of <i>in vitro</i> diagnostic examination	<i>Europe:</i> <i>In vitro</i> diagnostic medical device <i>USA:</i> medical device
Toothbrush	Clean the teeth, gums and tongue	<i>Europe:</i> toiletry and cosmetics products, unless the manufacturer makes a medical claim and then it is a medical device <i>USA:</i> medical device

2.3 Regulatory framework

In the summer of 1937, the clients of the S.E. Massengill Co. were asking for a liquid form of sulfanilamide, a substance that was safely used, in tablet and powder form, in the treatment of *streptococcal* infections. To meet this need, the company's chief chemist and pharmacist experimented and found that sulfanilamide would dissolve in diethylene glycol. The mixture was tested for flavor, appearance, and fragrance with satisfactory results and was shipped all over the USA. At that time, as there was no requirements for safety studies been done on new drugs, the company failed to note that diethylene glycol, a chemical normally used as an antifreeze, was a deadly poison resulting in the death of more than 100 patients (Collins 2004). This incident influenced the approval, in 1938, of the set of laws – the FD&C Act – that gave FDA authority to oversee the safety of food, drugs, and cosmetics. However, a regulatory system dedicated to medical devices was only created in 1976 with the Medical Device Amendments as a response to the Supreme Court decision in the Bacto-Unidisk Company case involving the an antibiotic-sensitivity disc (Wizemann 2010). Currently, in the USA, most of the regulations concerning medical devices can be found in Title 21 Code of Federal Regulations Part 800 to Part 1299 (abbreviated to 21 CFR 800 to 1299) and are enforced by the FDA, namely the Center for Devices & Radiological Health (CDRH) (Figure 2.1).

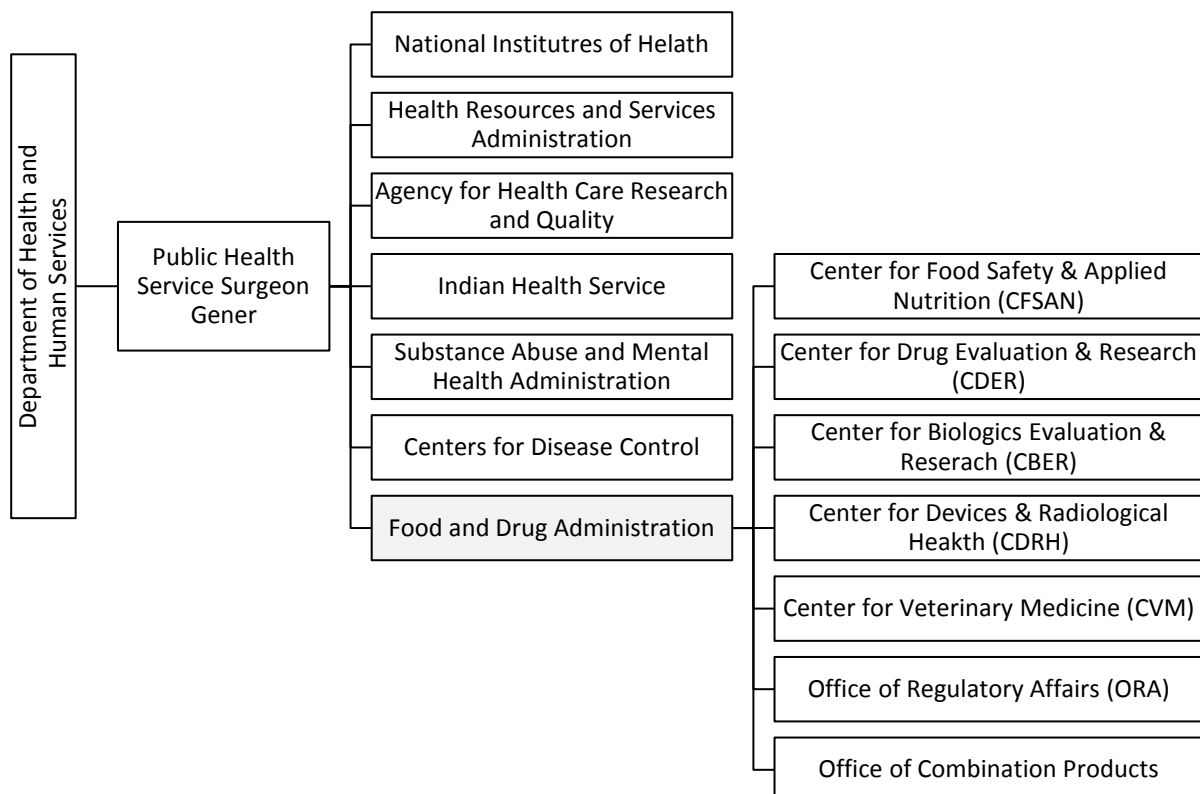

Figure 2.1: Organization of the Food and Drug Administration (FDA) in the USA.

The story of the European regulatory framework is similar to the American one. In the late 1950s, thalidomide was a drug taken by pregnant women for nausea and insomnia. However, in the early 1960s, this drug was withdrawn after being found to be responsible for over 10 000 human birth deformities (Kim and Scialli 2011). This tragedy stressed the need for the guidelines to test drugs,

foods, and environmental contaminants that were written in the following decades. As far as medical devices are concerned, the first regulatory system dates back to 1993. Prior to that date, each country had its own legislation, and the device’s registration varied from country to country (Davey et al. 2005). Nowadays, medical devices are regulated by three main Directives: the European Council Directive 93/42/EEC which covers most of the medical devices, the European Council Directive 90/385/EEC on active implantable medical devices, and the European Council Directive 98/79/EC on *in vitro* diagnostic medical devices (Table 2.4). In order for the requirements in the directives to be mandatory, the directives were transposed to each member state’s legislation resulting in a vast and elaborate legislative framework (Altenstetter 1996). To ensure the uniform application of the directives, it were created legally non-binding documents, such as the guidance documents MEDDEV (Directorate General Health & Consumers 2010), consensus statements, and interpretative documents.

Table 2.4: List of the European directives regulating medical devices.

European Council Directive	Description	Example
93/42/EEC	Concerns medical devices	Orthopedic implants Heart valves Medical software
90/385/EEC	Concerns active implantable medical devices	Pacemakers Implantable defibrillators
98/79/EC	Concerns <i>in vitro</i> diagnostic medical devices	Pregnancy self-testing strips Blood glucose self-testing strips
2000/70/EC	Amended the Directive 93/42/EEC and covers devices that incorporate as an integral part stable blood derivatives	
2001/104/EC		
2003/12/EC	Reclassifies breast implants into Class III	
2003/32/EC	Introduces specifications concerning medical devices manufactured utilizing tissues of animal origin	
2005/50/EC	Reclassifies total hip, knee and shoulder joints into Class III	
2007/47/EC	Amended the Directives 90/385/EEC, 93/42/EEC, and 98/8/EC	
2011/100/EU	Amended the Directive 98/79/EC	

In Europe, the responsibility for the regulatory cycle was assigned to three organizations: competent authorities, manufacturers, and third party certification organizations – notified bodies. In addition, if the devices are manufactured outside the European Union (EU), authorized representatives and distributors are also involved.

A competent authority (CA) reports to the Minister of Health in the member state and ensures that the requirements of the Medical Device Directives are transposed into each member state National Law and are applied. Each member state and CA has its own interpretation on how should

be carried out resulting in some differences within EU. The jurisdiction of each CA is limited to the country in which was created, but it exchanges information and attempts to reach common positions with other CAs. In fact, one of the CA's obligations is to participate in work groups from EU and permanent committees.

In addition to the transposition of the medical device directives into National Law, CAs are responsible for the surveillance of medical devices on sale in their own member state and the evaluation of adverse incidents. They are also responsible for the approval of clinical investigations, and the registration of class I devices and *in vitro* diagnostic medical device (IVDs) on sale.

CAs are responsible for appointing and supervising notified bodies; they can appoint as many as apply and meet the criteria.

Notified bodies (NB) are organizations accredited by a member state to assess whether a product meets specific standards. They are independent entities in the sense that they charge fees for their services and do not have any association with manufacturers, suppliers, or installers. They are impartial and competent; that is, they have qualified staff with special training and all necessary evaluation and verification experience. The NB responsibilities include advising on device classification and conformity assessment routes, pre-assessment of devices, evaluation of both product and quality system, evaluation of manufacturer's corrective actions, issuance of certifications, and maintenance of the programmed surveillance of devices in Europe.

The New Approach Notified and Designated Organization (NANDO) web site (European Commission 2011) has lists of NB. These lists are subject to regular update and include the identification number of each NB as well as the tasks for which it has been notified.

The standard ISO/IEC 17020 specifies requirements for the competence of bodies performing inspection, and for the impartiality and consistency of their inspection activities. Although the evaluation process should be the same in every NB, currently, there are some variations regarding how they are implemented. In addition, the fees charged vary from NB to NB being determined by the market. However, in the future, this may change since there is a working group in Brussels working in the standardization of both procedures and fees.

An authorized representative is required for any firm located outside the European Union and is defined in the Council Directive 98/79/EC as any natural or legal person established in the EU who was designated by the manufacturer to act as him regarding the obligations under the Directives concerning medical devices. Manufacturers located outside the EU must identify on the packaging, labeling, and sales literature of their products their authorized representative with the logo shown in Figure 2.2. The responsibilities of the authorized representatives include liaising between manufacturers and CA, notifying CA of the manufacturer's and the device's names, maintain the necessary documentation available for review by the CA, and participating in vigilance and post-market surveillance procedures.

By following standards and guidelines, it is possible to confirm the devices' safety and/or effectiveness, guarantee that they fulfill the quality standards and meet the terms of the legislation in effect. In general, standards are created by entities such as the International Organization for Standardization (ISO) or the Association for the Advancement of Medical Instrumentation (AAMI),



Figure 2.2: Example of the authorized representative logo.

and must be complied by those who make the products (manufacturers), who sell them (vendors), and also by those that use them (users). Manufacturers, vendors and users, considering the characteristics of the devices, have to identify which standards and regulations must be abided. Table 2.5 includes some examples of standards and regulations; a compilation of harmonized standards to be complied in Europe is available in the EU webpage (European Union 2012).

Table 2.5: Examples of standards and regulations that medical devices must comply with.

Type of document	Designation
Standards	ANSI/AAMI/ISO 11137 – Sterilization of Health Care Products Package
	IEC 60601 - Medical electrical equipment
	ANSI/AAMI EC11 – Diagnostic electrocardiographic devices
EU medical directives / regulations	Blood Product Directive 2002/98/EC
	Low Voltage 2006/95/EC
	Human Tissue Products Directives 2004 & 2005

As far as quality is concerned, in the USA, the quality systems for FDA-regulated products are known as Current Good Manufacturing Practices (CGMPs). Due to the diversity of products (food, drugs, biologics, and devices), the regulations provide a framework that all manufacturers must follow and adapt to their reality. Medical devices must abide the Quality System Regulations (QSR) - QSR CFR Part 820 - which is based on ISO 9001 and ISO 13485. In Europe, the quality management systems are described in the Annexes II and V of the Medical Device Directive. These annexes do not stipulate the type of quality system but is generally agreed that Annex II is equivalent to ISO 9001 plus ISO 13485 and Annex V is equivalent to ISO 9001 plus ISO 13485 without any design control.

Overall, the regulatory framework reflects the healthcare system of the country and influences manufacturing, the quality system, labeling, the clinical data required, fees (during the approval process), the modification pathway, i.e. how the following generation will be designed, among others. The components of a typical regulatory framework are summarized in Figure 2.3.

2.4 Classification

The medical device market can be divided into commodity and innovative products (Mehta 2008). Pulse oximeters and infusion pumps are two examples of commodity products. Commonly, this type of devices has low profit margins and is included in a broad portfolio of products of a large mature company. Commodity products have a long life cycle in the market, and their development is

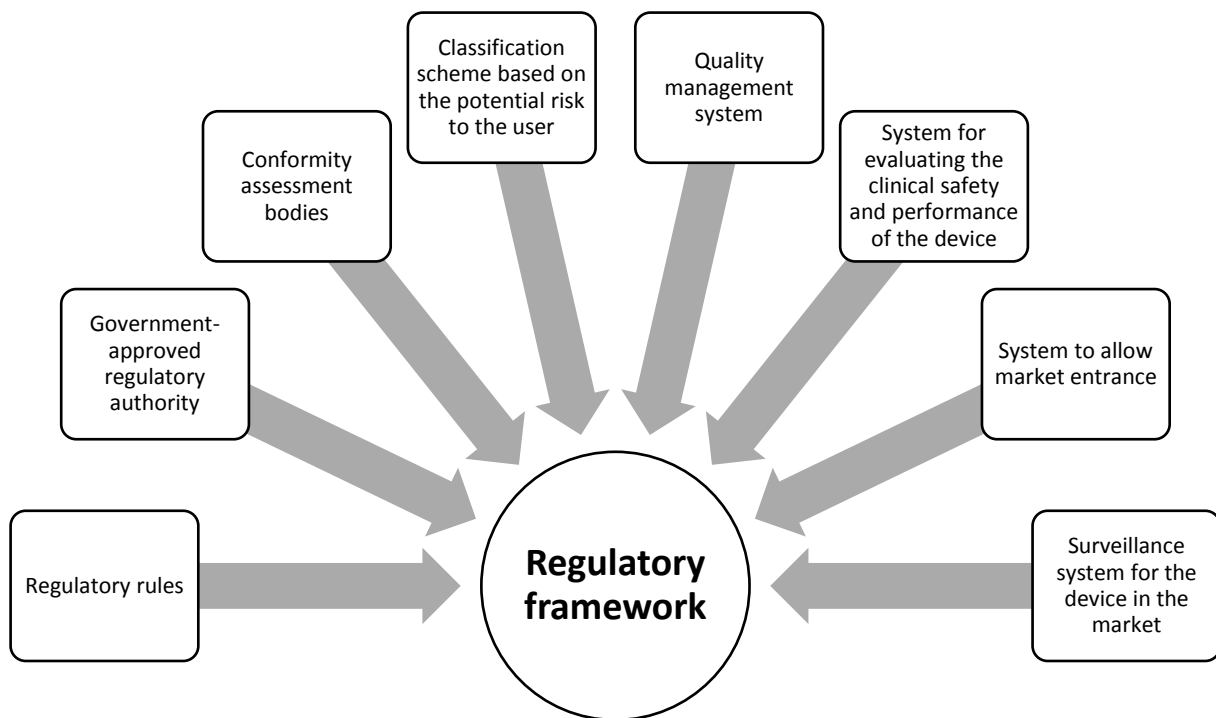

Figure 2.3: Components of a typical regulatory framework (adapted from (WHO 2010)).

characterized by incremental innovations that merely add specific features to the design. On the other hand, innovative products, such as stent-grafts and hip-protheses, have short product life cycles with each generation representing an evolution regarding the previous one. They are made by both large and small companies and provide high profit margins even though they require high investment in research and development.

Medical devices can be classified according to several criteria (Figure 2.4). From an academic point of view and considering the stage of healthcare in which they are used, they can be categorized as preventive (e.g. implantable cardioverter-defibrillator), diagnostic (e.g. x-ray), therapeutic (e.g. mechanical ventilator) and assistive (e.g. splints) (WHO 2010). It is also possible to distinguish between medical devices for general use (e.g. stethoscope) and disease-specific (e.g. implants) (WHO 2010). Considering the source of acquisition, one can distinguish between medical devices that require a prescription (e.g. insulin pump) and those that are sold ‘over the counter’ (e.g. exam gloves).

Considering the number of utilizations, there are devices for single use (e.g. needles) and multiple use (e.g. blood pressure meter). This means that there is a distinction between ‘placing a device on the market’, i.e. the initial action of making a product available for the first time, and ‘putting a device into service’, i.e. the moment of first use by the end user, which raises health and clinical safety issues pertinent in clinical practice, namely the performance and effectiveness, and the exposition of both patients and staff to unnecessary risk (Altenstetter 2003).

Table 2.6 summarizes the medical device’s classification in Europe, USA and according to GHTF, as far as risk to both patients and users is concerned. This categorization is related with the approval process: the higher the risk class, the more demanding the process is. In spite of the classes being similar, products considered class II or III in the USA might carry a different classification in Europe.

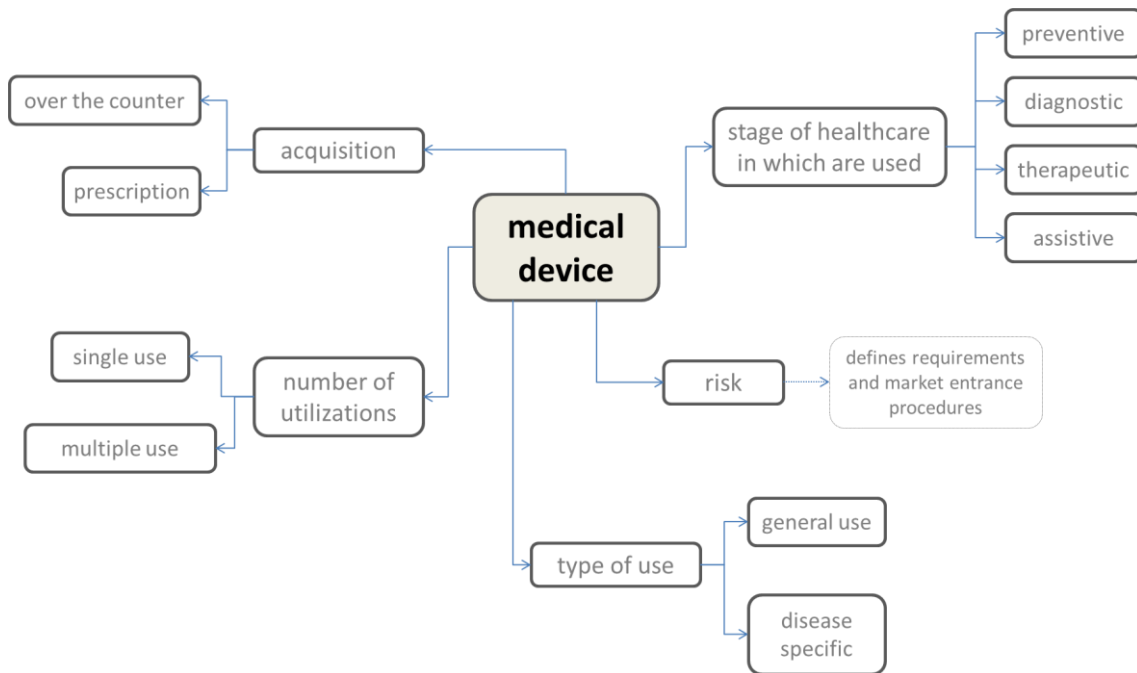

Figure 2.4: Multiple classifications for medical devices.

Table 2.6: Medical device's risk categorization and regulatory control in Europe, USA and GHTF.

System	Class	Risk level	Regulatory control	Examples
EU [§]	I Non-sterile Non-measuring Sterile Measuring	Low	Annex VII + Annex V for Sterile / Measuring aspects	Surgical gauze Wheelchairs
	Ila	Medium	Annex II or Annex VII + V or Annex VII + VI	Hearing aids Ultrasound equipment
	Ilb	High	Annex II or Annex III + V or Annex III + VI	Infusion pumps Surgical lasers
	III	High	Annex II or Annex III + V	Prosthetic joints Stent-grafts
USA	I	Low	General controls	Adhesive bandages Hospital beds
	II	Moderate	General controls Special Controls Premarket Notification [510(k)]	Blood pressure cuffs Sutures
	III	High	General controls Premarket Approval Application (PMA) or Humanitarian Device Exemption (HDE)	Pacemaker Vascular graft
GHTF	A	Low		Surgical retractors Tongue depressors
	B	Low-moderate		Hypodermic needles Suction equipment
	C	Moderate-high		Lung ventilator Bone fixation plate
	D	High		Heart valves Implantable defibrillator

[§] 'Annex' refers to the annexes of the Medical Device Directive 93/42/EEC.

Currently, these disparities pose considerable difficulties and limit the global implementation of medical devices (Davey et al. 2005).

Both the GHTF and the EU apply a set of rules to determine the device's class assuring that the same classification is attributed by multiple entities. The European classification requires the understanding and interpretation of 18 rules available in the Annex IX of the Medical Device Directive, which are explained in the guidance document MEDDEV 2.4 from June 2010. These rules classify devices based on potential hazards and possible failure, duration of contact with the body, degree of invasiveness, and local versus systemic effects. The European rules correspond, to a large extent, to the classification rules established by the GHTF in the guidance document GHTF/SG1/N15:2006.

FDA has established classifications for approximately 1 700 different generic types of devices and grouped them into 19 medical specialties – panels. Each device was then assigned to a regulatory class based on the level of control necessary to assure the safety and effectiveness of the device. This classification is risk based, and depends on both the intended use and indications for use of the device. In order to determine a device's class, as well as whether any exemptions may exist, one has to look for the device's name, or part it, in an online database available in the FDA's webpage (FDA 2012b). In case of doubt, according to section 513(g) of the FD&C Act (21 U.S.C. 360c(g)), one can ask the FDA's point of view about the classification and the regulatory requirements that may be applicable.

In healthcare, the term 'coding' refers to numeric and alpha numeric codes that healthcare providers use to document care and describe the services provided. These codes serve as register of hospital discharges as well as the basis for payment determinations and coverage, i.e. the protection offered by the healthcare provider. Examples of these codes are the Current Procedural Terminology (CPT) maintained by the American Medical Association (AMA) (Raab and Parr 2006a), the Healthcare Common Procedural Coding System (HCPCS), the International Classification of Diseases (ICD) (WHO 2012b), and the Diagnosis Related Groups (DRGs).

A team of the Yale University began the design and development of the DRGs in the late 1960s. DRG is a classification system that groups patients according to principal diagnosis, presence of a surgical procedure, age, presence or absence of significant comorbidities or complications, and other relevant criteria. Coding of DRGs is specific to each country but is often based on the ICD developed by the World Health Organization (WHO 2012b). Since the 1980s, DRGs were adopted in most high-income countries, on the one hand, to increase transparency of services provided in hospitals and, on the other hand, to incentivize the efficient use of resources by paying hospitals on the basis of the number and type of cases treated (Busse et al. 2011).

The nomenclature created by the Global Medical Devices Nomenclature (GMDN) Agency (Anand et al. 2010; GMDN Agency 2011) intends to provide regulators, conformity assessment bodies, health care providers, and medical device manufacturers with a single and global generic naming system for medical devices. It is up to manufacturers to determine the adequate code; however, that is only possible when the device is fully conceived because it is necessary to know exactly how the product works. Currently, the use of this codification is subject to the payment of fees, and is not mandatory.

The GMDN data is defined by three levels – device category, generic device group, and collective terms – differing in the degree of specificity. The device category is the broadest level; it divides the entire medical device product market into 20 possible categories (Table 2.7 shows the 16 categories presently established) based on the device’s application, technology, or other common characteristics. The generic device group aggregates medical devices based on common technology or intended use applying four terms associated with the generic device groups: preferred term (P), template term (T), synonym term (S), and multiple-linked synonym term (MS). Finally, collective terms are high-level device terms used to aggregate medical device groups that have common features within the GMDN; they can be device names (e.g. catheters) or device attributes (e.g. electrophysiology, home-use).

Table 2.7: Device categories currently established by GMDN.

Category	Description
01	Active implantable devices
02	Anesthetic and respiratory devices
03	Dental devices
04	Electro mechanical medical devices
05	Hospital hardware
06	<i>In vitro</i> diagnostic devices
07	Non-active implantable devices
08	Ophthalmic and optical devices
09	Reusable devices
10	Single use devices
11	Assistive products for persons with disability
12	Diagnostic and therapeutic radiation devices
13	Complementary therapy devices
14	Biological-derived devices
15	Healthcare facility products and adaptations
16	Laboratory equipment

2.5 Pathway to market

The path to market depends on the device’s risk classification. While in the USA, FDA ensures that medical devices are effective and ‘reasonably’ safe, i.e. the benefits outweigh the risks when the product is used as directed, in Europe, manufacturers must only demonstrate that the device is safe and performs according to its intended use, i.e. the product does what is supposed to do when it is used as directed. For instance, to market a laser to incise heart tissue to treat arrhythmia (abnormal heart rhythm), in Europe, the manufacturer must show that the laser incises heart tissue safely, while in the USA, the manufacturer must show that the laser incises heart tissue and treats the arrhythmia. Regarding the evidence presented, there are also differences; in the USA generally randomized and controlled trials are required while in Europe laboratory testing, literature reviews or small clinical trials suffice. These dissimilarities are responsible for significant differences in the amount of tests devices must pass, and the speed of introduction of the devices into the market. In fact, according to

Eucomed, the European organization representing designers, manufacturers, and suppliers of medical technology, in Europe medical technology is introduced 5 years earlier than in Japan and 2 year earlier than in the USA (Eucomed 2012).

In the USA, market approvals are carried out by a central regulatory authority (FDA) and the information that led to such decisions are disclosed to the public. In Europe, manufacturers choose and hire a notified body, and neither the approvals nor their evidentiary basis are disclosed to the public.

In Europe, as both the device and its manufacturing system are assessed, the approval process can only start when production has already started. In the USA, only the device is scrutinized, thus the approval process can begin as soon as the design freezes. This is actually a disadvantage since it becomes impossible to adjust the device to its manufacturing process.

As far as post-marketing surveillance is concerned, in the USA, FDA mandates post-marketing surveillance studies for class III devices and some class II devices as a condition of approval. In Europe, manufacturers are obliged to implement a 'vigilance system' to monitor their products once they are on the market (Salhieh 2007).

Both the European and the USA procedures are described next.

2.5.1 Europe

As far as medical devices are concerned, when referring to Europe or the European Union, one is referring to the current 27 member states plus the candidate countries and the members of the European Free Trade Association (EFTA) composed by Norway, Switzerland, Iceland, and Liechtenstein.

A medical device to be commercialized in EU has to present a CE mark – abbreviation of French 'Conformité Européenne' meaning 'European Conformity' – as shown in Figure 2.5. This mark is not a guaranty of safety, simply states that the manufacturer claims that the relevant Essential Requirements in the Directives are complied, and the device is fit for its intended purpose. In addition, it signifies that the product can be freely marketed anywhere in EU without further control.



Figure 2.5: Example of the CE mark; "xxxx" represents the four digit number attributed to the notified body.

The Essential Requirements in the Medical Device Directive can be divided into two groups: the first refers to a set of general requirements for safety and performance that applies to all devices, while the second is a list of specific and technical requirements regarding design and manufacturing that may or may not apply depending on the nature of the device.

In order to obtain a CE mark for their devices, manufacturers have to demonstrate and document compliance with the regulations, and issue a declaration of conformity. For low risk devices (e.g. gauze), manufacturers are allowed to affix a CE mark and register the product with the national competent authority which will afterward check, by auditing and inspecting, if the manufacturer complied with all the requirements. In certain situations, such as class I sterile devices (e.g. stethoscopes), it may be required the intervention of a Notified Body at the choice of the manufacturer. Class III devices (e.g. surgical sealants containing human serum albumin) require clinical studies, except when data already exists.

Clinical data is intended to demonstrate the device's safety and that it performs as intended by the manufacturer. In this context, the expression has a broad meaning and includes everything from bench testing to clinical trials in humans. It can be compiled from the literature or result from specifically designed clinical investigations. If the latter path is chosen, manufacturers must abide the standard ISO 14155 and the clinical trials must be pre-approved by a CA.

The various countries and languages in Europe affect the regulatory regime in two ways. First, labels and instructions must be translated into the national language of the country where the device is used. Second, manufacturers must provide evidence that the documents are translated when they are submitted to the CA before placing a product on the market (Altenstetter 2003).

Figure 2.6 summarizes the European path to market graphically. In general, manufacturers should pursue the following basic steps:

- (1) determine the risk class of the device according to Annex IX of the Medical Device Directive;
- (2) identify the directives and regulations appropriate for the device (notice that manufacturers can choose among methods for 'conformity assessment' of the device and/or manufacturing system);
- (3) implement the quality system in compliance with ISO 13485;
- (4) prepare the technical file or the design dossier demonstrating compliance with the Medical Device Directive 93/42/EEC;
- (5) appoint an authorized representative (if the company is located outside the European Union);
- (6) have a NB to audit the quality system and the technical file or the design dossier;
- (7) register the device with CA (if necessary); and
- (8) prepare the Declaration of Conformity and affix the CE mark to the device.

In the case of devices for clinical investigation and those that are custom made, the CE mark is not mandatory (Altenstetter 2003). The manufacturer has to follow Annex VIII and declare that its products conform to the Essential Requirements.

Overall, the evaluation process may take between three days to several months depending on the class of the device, the size of the manufacturer, the size of the technical file, and the duration of the clinical study.

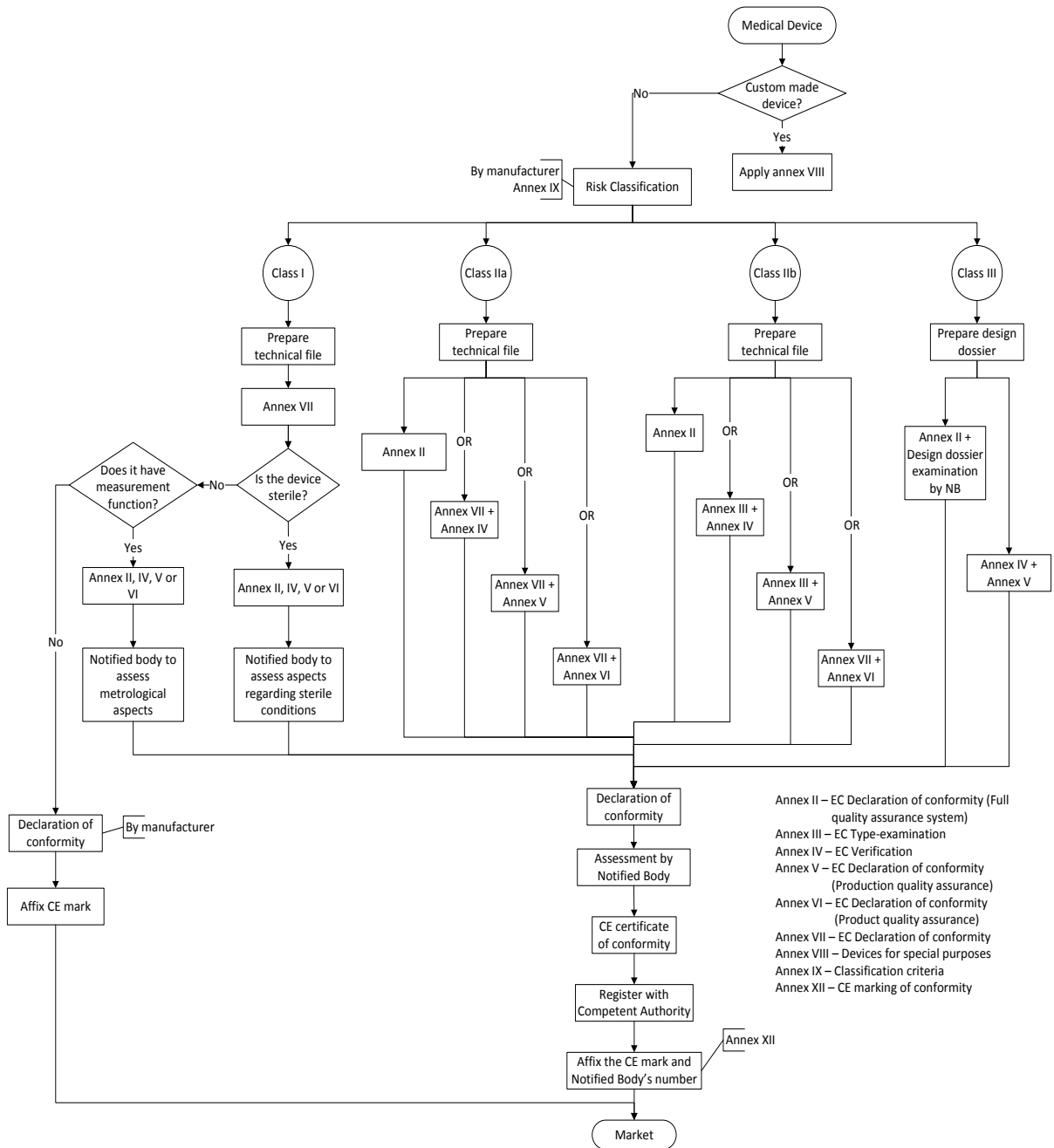

Figure 2.6: Flowchart with the European path to market.

Since May 2011, to contribute to a uniform application of the Directives and strengthen the market surveillance of medical devices in Europe, it is obligatory the use of Eudamed (European Union 2011), a repository for information exchange between CA and the European Commission. This database is not publicly accessible and contains information on medical devices and their manufacturers and authorized representatives, certificates that were either issued, modified, supplemented, suspended, withdrawn or refused, results of vigilance procedures, and clinical investigations.

2.5.2 USA

Medical devices for human use are regulated by the Center for Devices and Radiological Health (CDRH) of the FDA (FDA 2011b). Although this governmental agency uses third parties – accredited

persons – for the preliminary assessment of low- and medium-risk devices, it retains final authority over all devices' approval. In order to market a medical device, there are four options: 'exempt', 510(k), premarket approval (PMA), and humanitarian device exemption (HDE).

Most class I and some class II devices are exempt from the premarket notification 510(k) requirements. Nonetheless, they still have to comply with the general controls; that is, they must be manufactured under a quality assurance program, be suitable for the intended use, be adequately packaged and properly labeled, and have establishment registration and device listing forms on file with the FDA.

The 510(k) process is a 90-day review procedure based on the argument that the device is substantially equivalent (SE) – predicate device – to one that was already approved by the FDA. Most class II devices follow this path. In addition to the premarket notification 510(k) and the general controls, devices must comply with special controls, namely performance standards, guidance documents or implementation of post-market surveillance.

PMA, the most stringent type of device marketing application, is the process to evaluate the safety and effectiveness of class III medical devices. Although, FDA regulations provide 180 days to review the PMA and make a determination, the process can take between 6 months to 2 years depending on factors such as the report of clinical studies and quality of documents.

Some 510(k) submissions and most PMA applications require clinical data. In order to obtain this information, clinical trials must be done in accordance with the FDA's Investigational Device Exemption (IDE) regulation.

Prior to the FDA Modernization Act of 1997 (FDAMA), if an innovative device was found not substantially equivalent (NSE), it was classified as class III and a PMA was required resulting in a conflict between the need of being innovative and a more complex commercialization process. Currently, the *de novo* process allows the reclassification of the devices to class I or class II providing a simpler route to market for novel low risk devices. This process has a review period of 60 days and, if the device is classified into class I or II, the applicant receives an approval order to market the device. However, if it is determined that the device must remain in the class III category, it cannot be marketed until the applicant has obtained an approved PMA.

The use of the *de novo* route is a strategic decision and depends upon the product. The adoption of such route is influenced by factors such as the device's market and other barriers to market entry. For example, if there is insignificant patent protection, manufacturers can benefit from a class III classification because it will represent to competitors a barrier to market entrance.

The Human Device Exemption (HDE) is a specific path for class III medical devices designed to address diseases and conditions that affect fewer than 4000 patients / year in the USA; it aims to be an incentive for the development of devices for use in the treatment or diagnosis of diseases affecting small populations. An HDE is similar in both form and content to a premarket approval (PMA) application, but is exempt from the effectiveness requirements of a PMA.

Figure 2.7 summarizes the process to market a medical device in the USA. Usually, manufacturers must comply with the following basic regulatory requirements:

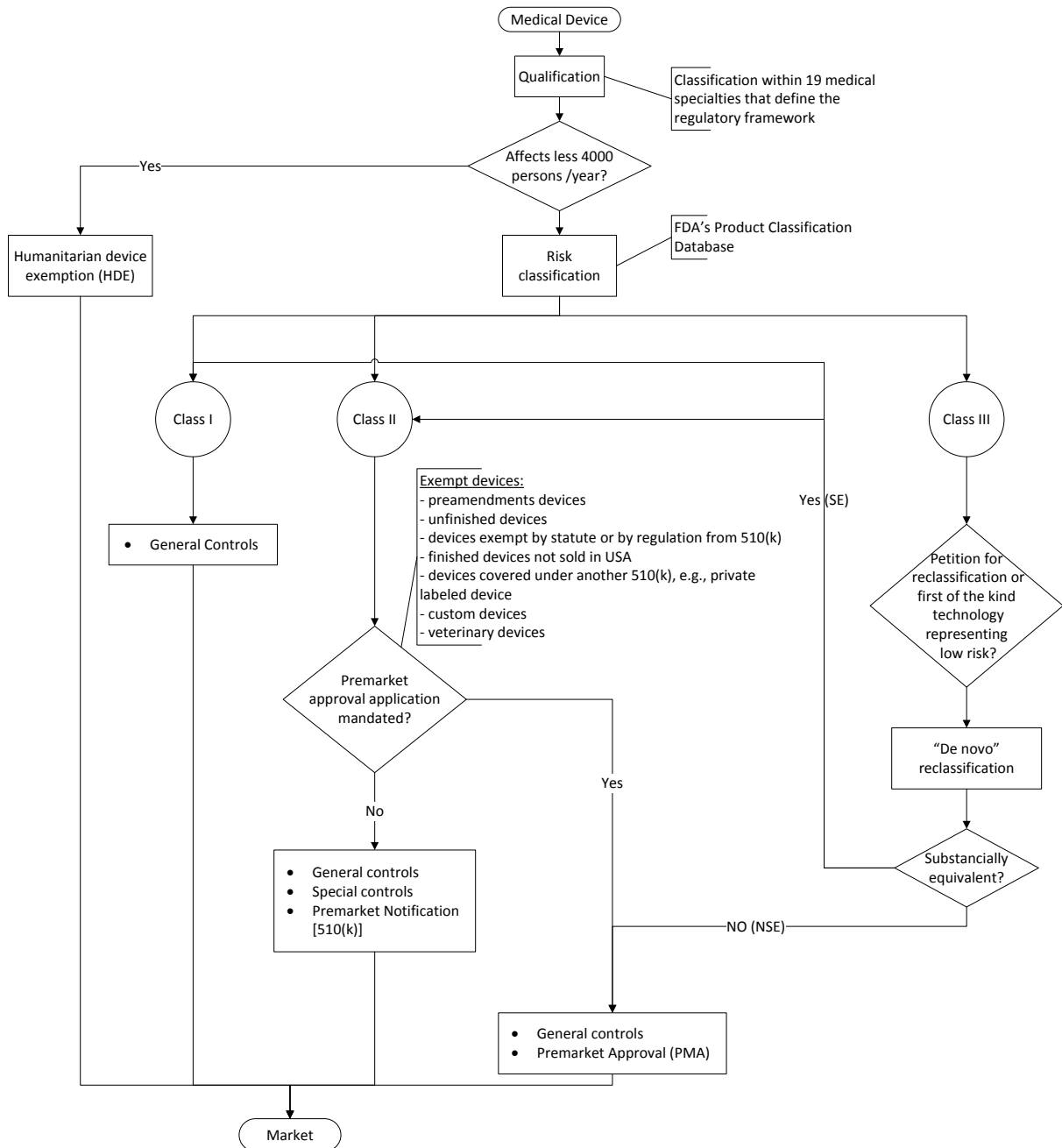

Figure 2.7: Flowchart with the USA path to market
SE – substantially equivalent; NSE – not substantially equivalent.

- (1) establishment registration and device / listing;
- (2) premarket notification 510(k);
- (3) PMA;
- (4) investigational device exemption (IDE) for clinical studies;
- (5) quality system regulation / good manufacturing practices;
- (6) labeling requirements; and
- (7) medical device reporting (MDR).

2.6 Post-market activities

As medical devices involve human safety, manufacturers have two obligations when they deliver a device to market: post-market surveillance and adverse event reporting (Tice et al. 2010). The first consists of active monitoring of medical devices during their use and allows the detection of rare but serious adverse events and long-term failures that are unable to be detected during the pre-market surveillance due to the short duration of the clinical studies and/or the limited number of participants. In addition, it allows the identification of complications related to inexperience and improper use of a device as well as 'off-label use' of the devices. The risk that was estimated before the device entering the market can now be actually measured, and the data gathered is essential to monitor the device's safety and effectiveness that in turn is used to determine if the device merits coverage and/or reimbursement. The data is also used for the development of new versions of the devices or completely new products.

An adverse event refers to those situations that led (or might have led) to one of the following outcomes: death of a patient, user or other person, or serious deterioration in state of health of a patient, user or other person. Regulators must be informed of these events, and the reports may arrive from three sources: manufacturers who report a serious injury or a death; users and other third parties who report the malfunction of a medical device; and competitors who complain about noncompliance by another manufacturer. FDA maintains a database, called Manufacturer and User Facility Device Experience Database (MAUDE), to collect such data (FDA 2011c). In Europe, manufacturers should notify their authorized representative (if applicable) and issue a Field Safety Corrective Action (FSCA) under the Medical Device Vigilance System.

The adverse event reporting is a passive process since reports are received as they occur and are declared; it can be said that is unreliable and allows a large proportion of events underreported. Furthermore, it does not provide data regarding the number of devices at risk for a given adverse event making impossible to calculate an incidence rate.

One of the goals of post-market surveillance is to reduce the likelihood of a same type of adverse incident being repeated in a different place at different time. Thus, both manufacturers and healthcare systems are held responsible for the proper functioning of medical devices. Especially in the USA, adverse events can lead to legal disputes with manufacturers, health care providers and/or operators thus reducing income revenues due to liability charges as well as reduction of sales by harming the customer's confidence in the manufacturer.

2.7 Recall

A recall refers to any action taken by a manufacturer or vendor to either remove a product from the market, correct it, or to notify its owners about the product's defectiveness or potential defectiveness. Any product can be recalled, for example, consumer goods, food, and child safety seats, and some industries, such as aviation and medicine, have clearly defined regulatory guidelines

for the procedure.

As far as the impact of a recall is concerned, besides lowering the revenues resulting from the loss of sales, a company has costs to implement the recall process, to correct or replace the product, with the unsold inventory, and with eventual fines and legal disputes (Thirumalai and Sinha 2011).]. In addition to the financial costs, the company's reputation and the physical and psychological well-being of the consumer are affected. Nonetheless, recalls are common.

As medical devices involve human safety, one would expect that recalls would be rare. However, the opposite occurs. According to the Food and Drug Administration (FDA), between 2007 and 2011, across the USA, there were at least 160 recalls, that is, approximately one recall every 11 days. In Europe, as there is no centralized authority for approvals and tracking of medical devices, it is difficult to trace the number of recalls, but a 2011 report from the Boston Consulting Group shows that the number of recalls in Europe is similar to the one in the USA (Davis et al. 2011).

Medical device recalls can either be voluntary or imposed by a regulatory body (e.g. competent authorities in Europe or the FDA in the USA). Their motives are assorted and include, but are not limited to, malfunction, microbial contamination or such a possibility, violation of regulations, quality failures like manufacturing defects, packaging and labeling errors, software glitches, and the device giving incorrect answers. Depending on the severity of the defect detected, the company has to adopt a suitable recall strategy which comprehends the depth of the recall (Figure 2.8); communications through press releases, website of the manufacturer, trade journals, and newspapers; notification of the users; timeliness; and progress reports.

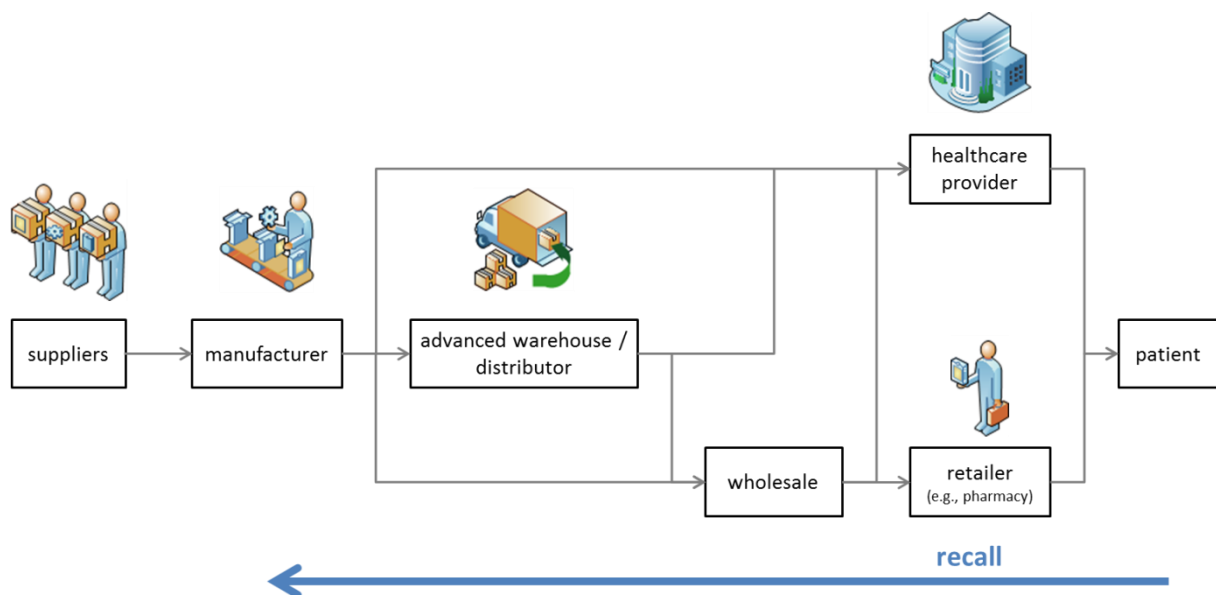

Figure 2.8: Supply chain of medical devices. The recall depth refers to the level of distribution from which a device is recalled (wholesale, retailer or consumer).

The removal of a medical device from the market can be done resorting to recalls, market withdrawals, and corrections. While a market withdrawal refers to the removal or correction of a distributed product, a correction refers to repairs, modifications, adjustments and relabeling of the devices while they are still under the control of the manufacturer and do not need to be physically

removed to some other location. These actions should not be confused with stock recovery, which is not considered as a recall, and refer to the removal or correction of a device that has not been distributed or that has not left the direct control of the company.

According to the FDA, recalls are classified into three classes considering the relative severity of the health hazard presented by the product (Table 2.8). They are subject to FDA news release and are listed on the FDA webpage (FDA 2012c).

Table 2.8: FDA’s classification of the medical device recall (adapted from (FDA 2012d)).

Class	Description
I	A situation in which there is a reasonable probability that the use of, or exposure to, a violative product will cause serious adverse health consequences or death
II	A situation in which use of, or exposure to, a violative product may cause temporary or medically reversible adverse health consequences or where the probability of serious adverse health consequences is remote
III	A situation in which use of, or exposure to, a violative product is not likely to cause adverse health consequences

In Europe, there is no harmonized definition of recall. This term is often used as a synonym of a Field Safety Corrective Action (FSCA) which is defined, in the guidance document MEDDEV 2.12-1 from December 2009, as ‘an action taken by a manufacturer to reduce a risk of death or serious deterioration in the state of health associated with the use of a medical device that is already in the market’. FSCAs may include the return of a medical device to the supplier, a device modification, exchange or destruction, or an advice given by the manufacturer regarding the use of the device. These actions should be notified via a Field Safety Notice (FSN), and copies of the document should be sent to the competent authorities (CA) of the countries where they are applicable as well as the CA in the country where the notified body (NB) which made the attestation that led to the CE (of the French ‘Conformité Européenne’ meaning ‘European Conformity’) marking is situated.

In spite of recalls being negative surprise events, they act as catalysts of search and learning (Thirumalai and Sinha 2011). By adopting design tools such as failure mode and effects analysis (FMEA) or design philosophies like ‘safety by design’, it is possible to reduce the probability of a recall. Nonetheless, to reduce the impact of such event, during the development of a new device one should prepare the recall procedures.

2.8 Market

In his seminal paper, Arrow (Arrow 1963) asserted that the principal characteristic of healthcare was uncertainty because no one knows, on the one hand, when will become sick and, on the other, which treatment will need and how much it will cost. As far as healthcare spending is concerned, in some countries like the USA, the value is largely driven by market forces while in others it is a political decision. Furthermore, doctors (sometimes) charge different fees to different people considering their income, and generally, the provider’s principal motivation is not the maximization

of profit. Medical devices, as one of the components of healthcare, share these characteristics.

Several sources describe the medical device industry as dynamic and in continuous growth. For example, Eucomed claims that, in Europe, there are almost 22 500 medical technology companies (80% are small and medium enterprises) employing nearly 500 000 people and generating sales revenues of over €95 billion per year (EUcomed). The USA's market is considered the world's largest and is estimated to worth US\$105.8 billion in 2011 (Espicom Healthcare Intelligence 2012).

The growth of the sector can be explained by a series of factors. For instance, the need for devices to be used in the training of healthcare professionals, new and more healthcare technologies and services due to aging of the population, the increase of diseases and co-morbidities, and the evolution of the character of illnesses from acute and infectious types towards chronic ones. New life styles have revealed new diseases such as obesity and there is an increased focus on prevention, e-healthcare and the shift to community and home care that lead to the development of new market segments. The copayment of healthcare treatments resorting to medical devices also increases demand. As resources are limited and it has been shown that medical technology contributes to the reduction of the length of hospital stays and thus healthcare costs, there is a demand for more efficient and low cost solutions as well. The sector also benefits from advertising and the multiplicity of sales channels such as local shops, pharmacies, and online stores.

A restriction to the growth of the sector is the fact of medical technology being considered a cost-driving force; this puts the medical device industry under intense scrutiny and regulation, and healthcare payers and purchasers demand the demonstration of the product's cost/benefit. Health technology assessment (HTA) not only represents a hurdle or a cost to manufacturers, but also creates expectations regarding the quality of the medical care and the efficacy of the treatment. Furthermore, its results decide if coverage and reimbursement are provided impacting directly on the manufacturers' attainable revenues. For example, among the criteria for adoption of healthcare technology, the UK's National Institute for Health and Clinical Excellence (NICE) has adopted, since its inception in 1999, a cost effectiveness threshold range of £20,000 to £30,000 per quality adjusted life year (QALY) gained (Appleby et al. 2007).

Medical technology companies have to face a myriad of trade issues that vary from country to country. This means that firms without sufficient resources to conduct necessary market research are especially vulnerable. Moreover, as the device's life cycle is short, ranging between 8 and 24 months (Vallejo-Torres et al. 2008), they have little time to recover the investments.

The demand for medical devices is driven, in one hand, by the 'demand pull' of the aging population and, on the other, by the 'technology push' of new medical technologies due to both patients and doctors seeking the latest technologies for treatment.

The industry is relatively new, highly fragmented, and consists of small niche markets with few products. Most companies are small and medium-sized, and it is common to start as university spin-offs relying in a single device or technology (Eatock et al. 2009). For this reason, often companies have limited resources to face the regulatory requirements, and it is difficult for them to survive a failure in the marketplace. Mergers and strategic alliances are frequent, representing a quick and effective way of manufacturers to gain new product lines and technologies as well as enter new

markets.

The development of medical devices is both capital and technologically intensive. New technologies are generally brought to market by start-up companies while large companies develop successive iterations of existing devices. As medical devices are highly substitutable by similar products with superior efficacy, profits depend on new solutions which compel manufacturers to be constantly innovating, researching, and presenting new solutions.

The medical device industry is known for its considerable investment in research and development (R&D) and the use of advanced technology. In fact, according to Eucomed, in Europe, around 8% of sales are reinvested into R&D and, in 2009, the medical technology industry filled almost 16 500 patents, which is equivalent to more than 12% of the total applications in Europe (EUcomed).

2.9 Adoption factors for medical devices

During the early 19th century, thousands of women died from puerperal fever also known as 'childbed fever'. This rampant disease, responsible for acute symptoms of severe abdominal pain, fever, and debility, was widely attributed to miasma (an illness-carrying vapor) or intrinsic factors related to the patient. However, the difference between the mortality rates of two clinics (or wards) in the maternity of the Vienna General Hospital puzzled the Hungarian physician Ignác Philipp Semmelweis (1818–65) (Best 2004; Stewardson and Pittet 2011).

Dr. Semmelweis had precise records of maternal mortality rates and was faced with the fact that ward one had a consistently higher mortality rate compared with ward two. Both wards were identical regarding the layout and infrastructure sharing a common anteroom and patients were allocated to wards on the basis of the day of the week of their presentation to the hospital (quasi-randomization). The only difference between wards was the fact that one was staffed by doctors and medical students (that conducted autopsies), whereas the other was run by midwives.

The death of Semmelweis' friend, the pathologist Jakob Kolletschka, from a febrile illness resembling childbed fever after a cut during an autopsy of a woman that had died from puerperal fever, made him suspect that doctors were causing diseases among maternity patients. Thus, he introduced mandatory hand washing with chlorinated lime before entering the maternity wards. This simple procedure helped to reduce the maternal mortality rate. However, this finding was either ignored or ridiculed. There are several explanations for this, namely the lack of an explanatory model on which to base Semmelweis' claims (the germ theory of disease was 30 years away) and even politics (Semmelweis' was a Hungarian belonging to a German-speaking ethnic minority in Vienna). It has also been suggested that doctors were unable to accept that they could be agents of death (Buonomano 2011).

In spite of the facts presented by Semmelweis, the behavioral change took several years to occur. This story illustrates that there are diverse factors affecting the diffusion and adoption of healthcare technologies that go beyond scientific evidence. In this context, diffusion refers to the process by

which an healthcare technology is communicated through certain channels over time among healthcare professionals, patients, caregivers, and people with special needs (Rogers 1995). The concept of adoption is similar to the one of diffusion, but differs from it in the sense that includes the psychological processes an individual goes through in order to use a technology.

The diffusion process is typically represented in a graph measuring adoption rate (acceptance) over time. Most innovations have an S-shape curve in which the slope indicates the speed of adoption (Figure 2.9). In healthcare, this slope is influenced by varied factors, namely opinion leaders, communication channels, potential value of the innovation relative to the current practice, ability to try the innovation, and infrastructures or other technologies that cluster with the innovation (Cain and Mittman 2002; Greenhalgh et al. 2004).

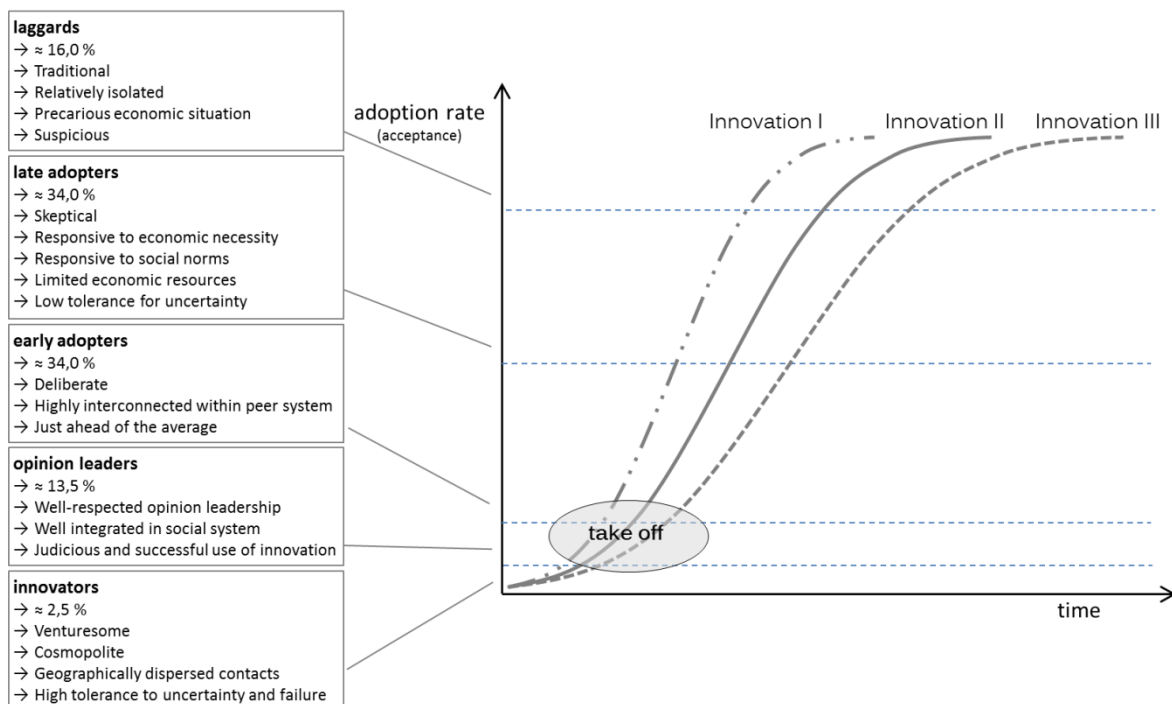

Figure 2.9: The diffusion process and description of technology adopters (adapted from (Rogers 1995)).

Medical devices can be bought specifically for a patient and/or medical procedure or in a bundle for medical supplies. The buyer can either be individuals (e.g. patients) or organizations (e.g. hospitals). Depending on the situation, the adoption criteria change but, due to the complex nature of medical knowledge, buyers place trust in the physicians, which are supposed to advice according to the clinical need, free of bias and financial inducements. Notice that, in spite of the existence of diagnosis and treatment guidelines (e.g. NICE clinical guidelines (National Institute for Health and Clinical Excellence 2012)), physicians adopt different medical approaches or protocols, and the human nature makes people’s perspectives change depending on whether they are dealing with abstract statistical populations or with their own family (Hanna et al. 2001). As far as healthcare technologies are concerned, it is difficult to test products before consuming them and ‘shop around for the best deal’.

Overall, the acquisition of a medical device depends on its features (what it does), if conforms with the legislation, its efficacy (ability to produce the intended result), performance (ability to fulfill

the intended purpose), safety (risks to users during clinical practice) and reliability (consistency of performance and safety) (Nobel 1991). The awareness of the technology’s potential, the adaptability to the user, the ease of use, the existence of appropriate training (Arntzen-Bechina and Leguy 2007) and the customer support are other influencing factors. Biomedical ethics principles, namely beneficence, non-maleficence, respect for autonomy and justice, can also affect the adoption of novel medical devices (Paola et al. 2010).

Economics is important in the dynamics of the adoption of a medical device but is not crucial. Buying a device simply because is cheap may be an error; one should consider who will pay (e.g. patient, healthcare provider, insurance company), how costs will be allocated (consumables vs. capital goods), the device’s life cycle, and its cost-effectiveness (Ison 2000; Neumann 2005).

Although patients pay for their medical treatments, is more common to find insurance companies and governments in the role of payers, thus, without coverage or reimbursement, many patients would be unwilling or unable to pay for their treatments (Boriani et al. 2011). In addition, reimbursement tariffs, by setting the prices that can be paid, not only influence the use of medical devices by the healthcare providers and the demand, but also impact the revenues of the manufacturers and incentives to develop novel solutions.

The increasing pressure to reduce healthcare spending makes it difficult to conciliate cost-containment with access to healthcare technologies since new technologies are in general more expensive than the ones they aim to replace. In this scenario, health technology assessment (HTA) is used to set priorities on the use of resources. For governments and regulators, HTA has the additional role of helping to create policies that ensure the public’s safety and social equity.

HTA evaluates systematically the properties and effects of healthcare technologies investigating their attributes, specifically performance characteristics, safety, efficacy, effectiveness, social, and economic impacts (OReilly et al. 2009). The economic analyses are used to compare the resources consumed with the health outcomes obtained. While the inventory of resources and its expression as monetary units is similar across most economic evaluations, the consequences from each alternative may differ considerably. Hence, three types of economic analyses can be considered: cost effectiveness analysis (CEA), cost utility analysis (CUA), and cost benefit analysis (CBA) (Table 2.9).

Table 2.9: Types of economic analyses and measurement units.

Type of economic analysis	Cost measure	Outcome measure
cost effectiveness analysis (CEA)	monetary units	any intermediate (e.g. number of cases detected), clinical (e.g. mortality), or patient-reported (e.g. pain) outcomes
cost utility analysis (CUA)	monetary units	quality-adjusted life years (QALYs)
cost benefit analysis (CBA)	monetary units	monetary units

In CEA, the consequences of different interventions are measured and compared using a single outcome, e.g. life-years gained, deaths avoided, millimeter of mercury (mmHg) drop in diastolic blood pressure, or cases detected (Gold et al. 1996; Sprague et al. 2007). In spite of the limitations of this type of analysis and the public’s perception that decisions are based solely on costs, it can be a driver for the development of solutions that really matter. CUA is a type of cost-effectiveness analysis

in which consequences or outcomes are measured in utilities (Sprague et al. 2007), usually quality-adjusted life years (QALYs).

In CBA, the consequences are valued in monetary units (Sprague et al. 2007). This represents an advantage since it can be conducted for just one technology, and the net benefit can be calculated immediately determining if a technology is worthwhile or not.

Considering the diversity of medical devices, further studies are needed to determine which economic analysis is more suitability to each medical device. In addition, further studies are needed to understand the impact of HTA on both pricing and reimbursement.

Figure 2.10 summarizes the factors that influence the adoption of medical devices. By considering these factors during the development of a new device, it is possible to increase its diffusion and adoption.

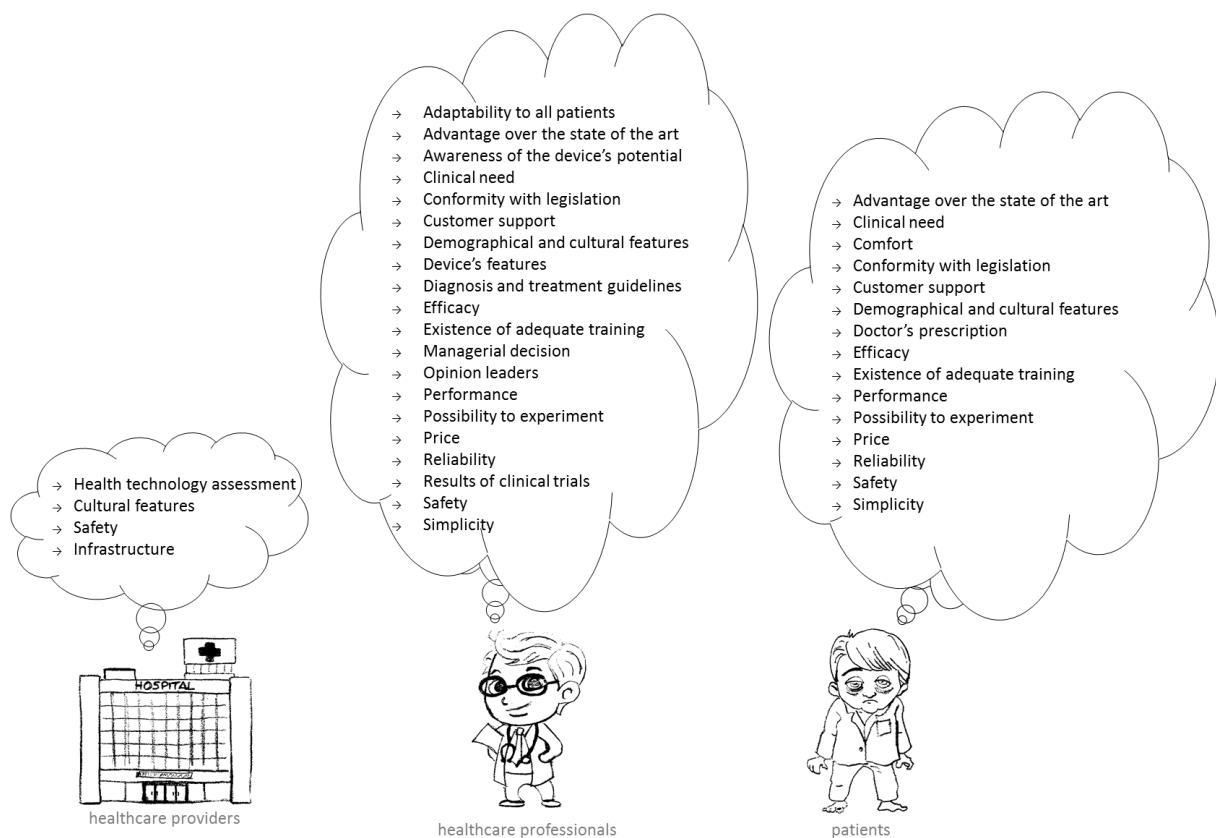

Figure 2.10: Factors influencing the adoption of medical devices.

2.10 Pricing

Like any other industry, in the medical device sector, each manufacturer has its own method to determine the price of its products. Sellers can either set their prices or bargain with the buyer. In either way, manufacturers generally aim to recover the costs associated with the research and development process, cover the operating costs (fixed and variable costs associated to the production, marketing, and sales departments), and obtain a profit margin. In addition, variables

such as price elasticity, market share, competition, and brand identity are also considered.

Devices like needles and blood bags are sold in competitive commodity markets; as they are essentially uniform across producers, price usually plays the most important role. On the other hand, more expensive and specialized devices, like magnetic resonance imaging (MRI) machines and artificial knees, operate in oligopolistic markets, i.e. the market is controlled by a small number of sellers (Pauly and Burns 2008), or to be more exact, in 'differentiated oligopolistic markets', because although the products available are similar, they not always are perfect substitutes.

In healthcare, price is a delicate issue because few are willing to accept that health is a consumer good, that is, it is possible to attribute a price. Thus, it is commonly accepted prices not being disclosed, and manufacturers charge distinct prices to different buyers (Pauly and Burns 2008; Reinhardt 2006; Rogalewicz et al. 2011). However, this scenario may change with the spreading of initiatives such as Peto (Peto.co.uk 2011), an information portal that, since January 2012, allows buyers from the UK's National Health Service (NHS) to compare both supplier and product information.

Hutchings (Hutchings 2010) studied the factors that influenced the medical devices' effective price and identified the following features:

- clinical and other benefits;
- health economic and social benefits;
- manufacturer investment in local country;
- investment in the product's research and development;
- cost of goods and profit margin;
- technological advancement;
- patent and marketing exclusivity;
- comparator product price;
- budget impact;
- equity; and
- rarity and burden of the disease.

2.11 Reimbursement

'To reimburse' is defined as to repay someone who has spent or lost money. In healthcare, healthcare providers or patients pay for treatments at the time of their delivery but later, either the national health fund or a private health insurer, repays the costs in whole or in part. Normally, reimbursement systems do not aim to fund healthcare; by setting the levels of reimbursement, they are used to control and reduce healthcare spending.

Table 2.10 lists organizations involved in the reimbursement process in the 8 countries with the highest health expenditure in 2009. Each entity has its own mechanism to determine the reimbursement values (Schreyögg et al. 2009) but often private insurers follow the decision taken by government bodies. The adopted requirements seem to change and evolve over time; overall, data

on clinical efficacy, risks, benefits, and costs are evaluated (Raab and Parr 2006c; Raab and Parr 2006b; Raab and Parr 2006a). Many government bodies, as France, Germany and Italy, have adopted reimbursement systems based on diagnosis-related group (DRG) coding (Busse et al. 2011). In this system developed in the late 1960s by a team of the Yale University, similar and related procedures are grouped together, and then it is attributed a code that corresponds to a given value that is the set amount of money that is reimbursed.

Table 2.10: Organizations involved in the reimbursement process in the 8 countries with highest health expenditure in 2009 (the list is not exhaustive).

Country	Organization	webpage
Canada	Patented Medicine Prices Review Board (PMPRB)	www.pmprb-cepmb.gc.ca
	Common Drug Review (CDR)	www.cadth.ca
France	Commission Nationale d'évaluation des Dispositifs Médicaux et des Technologies de Santé (CNEDiMTS)	www.has-sante.fr
	Comité Economique des Produits de Santé (CEPS)	www.sante.gouv.fr
Germany	Institut für das Entgeltsystem im Krankenhaus (InEK)	www.g-drg.de
Italy	Agenzia Italiana del Farmaco (AIFA)	www.agenziafarmaco.gov.it
Japan	Pharmaceuticals and Medical Devices Agency (PMDA)	www.pmda.go.jp
Spain	Ministerio de Sanidad, Servicios Sociales e Igualdad	www.msc.es
United Kingdom	National Health Service (NHS)	www.nhs.uk
United States	Centre for Medicare and Medicaid Services	www.cms.hhs.gov

Medical devices can be reimbursed after being recognized that they either provide a health benefit in its own (e.g. in France), or as a resource used in a procedure that provides a health benefit (e.g. Germany and Italy). In the latter, the payment of the medical device comes within a budget, while the first modality removes the temptation of using a cheaper device when a more expensive is clinically more appropriate.

Commonly, there are two types of reimbursement lists: a positive and a negative one. The latter comprises devices and procedures to which reimbursement is prohibited from either public or private funds. In general, an item is included in this list after a bad outcome of HTA; the decision is generic, not brand specific. In some countries, such as Spain, being in the negative list also means that the device and/or procedure cannot be sold in the related market.

A positive list includes medical devices and procedures that can be reimbursed along with the value of reimbursement. Generally, to be included in such a list, a code has to be attributed to the device or procedure, and then it has to be approved and officially listed. The approval process can be long (around 3 years (Frost & Sullivan Research Service 2008)) and, consequently, affect the adoption and implementation of medical technologies.

Reimbursement lists vary between country to country, public and private healthcare providers, hospital and outpatient care and, in some cases, then even vary by geographical region (e.g. Germany).

The value of the reimbursement is determined by the payer, that is, the government body or the healthcare insurance company. If the value of the reimbursement is not enough, the manufacturer has to demonstrate that the extra benefits are worth the additional reimbursement. Like a process to claim reimbursement, adjustments to the reimbursement value take around 3 years to conclude and,

in the meanwhile, the device should not be commercialized in order not to compromise the request made.

To support HTA used in reimbursement decisions, it can be considered data from results of randomized clinical trials, comparative studies, case studies, independent expert opinion, and reports from expert committees.

2.12 Ethics

'Primum non nocere' or *'primum nil nocere'* are two phrases in Latin that mean 'first, do no harm'. Every physician knows them because is one of the fundamental principles of biomedical ethics that are taught in medical school. Those involved in the development, manufacture, regulation, and approval of medical devices should also be familiar with them because, like physicians, they play a role in the diagnosis, prevention, monitoring, treatment, or alleviation of a disease or an injury. However, this role is hidden because the contact with patients occurs during the development process (voice of the customer and prototype testing), market entrance (clinical trials), commercialization (advertising), and post market activities (HTA and reimbursement clinical trials).

In the medical field, there are four ethical principles that are commonly accepted: beneficence, non-maleficence, justice, and respect for autonomy. The two first principles are inter-related; while beneficence is the obligation to provide benefits to patients, non-maleficence refers to the obligation to not inflict harm on patients (unless that is outweighed by potential benefits). In both cases, one has to ensure that treatments and medical devices are effective and able to provide safe treatments. These principles are supported by the following specific rules (Paola et al. 2010):

- Protect and defend the rights of others;
- Prevent harm from occurring to others;
- Remove conditions that will cause harm to others;
- Do not kill;
- Do not cause pain or suffering.

The principle of justice concerns how social benefits and burdens should be distributed; it may be interpreted as fair, equitable, and appropriate treatment in light of what is due or owed to persons (fair access to treatment).

Respect for autonomy refers to the right to hold views, to make choices, and take actions based on personal values and beliefs. Hence, choices should be made by those that have decision making capacity (are competent), are free of controlling constraints (voluntary), and are adequately informed. This principle is supported by a number of specific rules, including (Paola et al. 2010):

- Tell the truth;
- Respect the privacy of others;
- Protect confidential information;
- Obtain consent for interventions with patients;

→ When asked, help others make important decisions.

The nature of medical devices makes them prone to financial, non-financial, individual, organizational, and societal conflicts of interest (Table 2.11 and Figure 2.11), i.e. a set of conditions in which professional judgment concerning a primary interest, such as a patient's welfare, tends to be unduly influenced by a secondary interest, such as financial gain (Holmes et al. 2004).

Table 2.11: Players in the development of medical devices and their roles in potential conflicts of interest (adapted from (Holmes et al. 2004)).

Physician	Institution	Industry	Lay press	Scientific press	Regulatory body
Caregiver	Developer	Developer	Educator	Educator public	Reviewer
Investigator	Investor	Marketer	(public)	Educator	Approver
Researcher	Guideline writer	Educator public	Watchdog	physicians	Rejector
Author	Policer	Educator	Bully pulpit role	Peer reviewer	Overseer
CEO	Guardian	physicians		Bully pulpit role	
Peer reviewer	Care provider	Inventor			
Inventor					
Consultant					

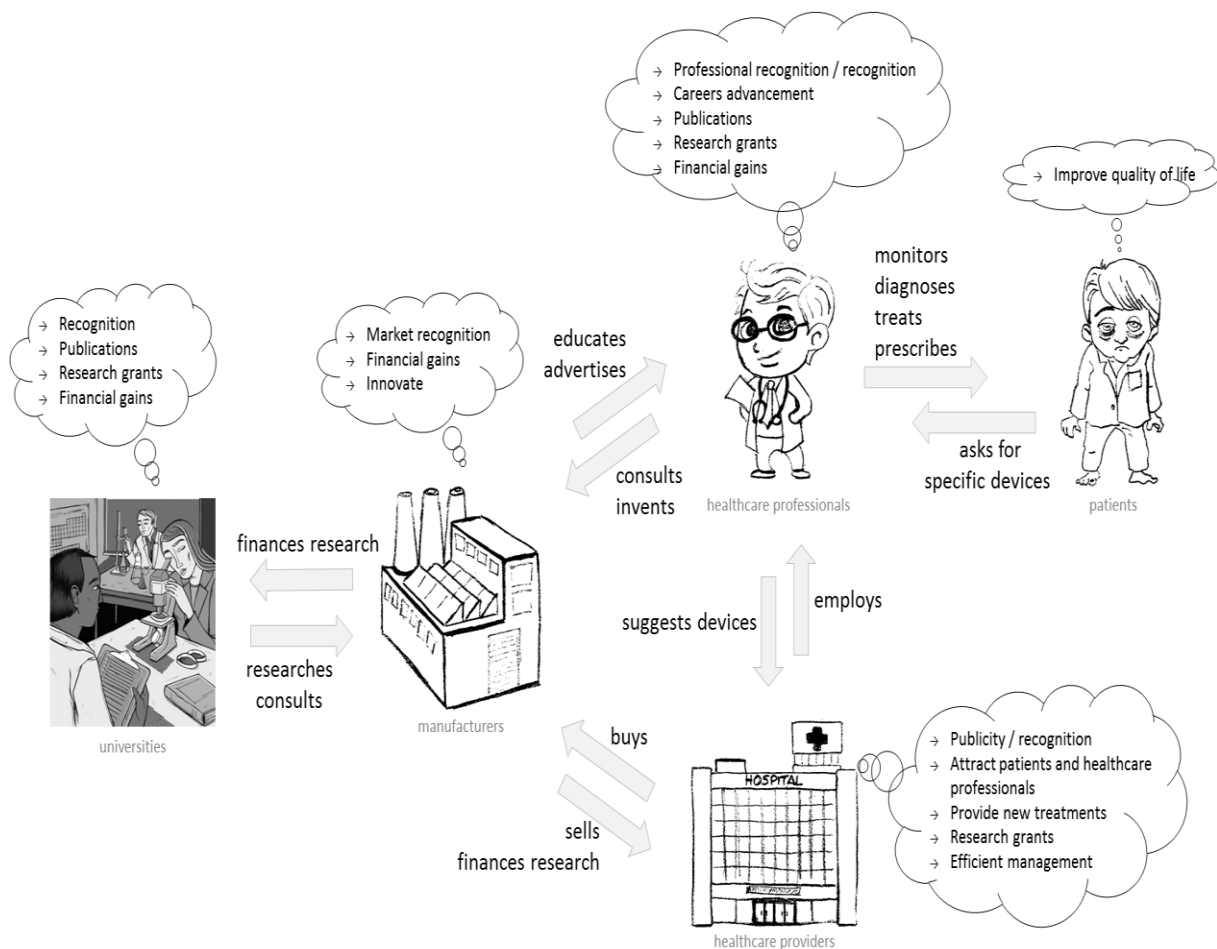

Figure 2.11: Players in the development of medical devices, their interest and interactions; conflicts of interest may occur when there are adverse interests of both parties.

Ethical dilemmas may appear at any stage of the development process, since the identification of a need until post market activities. For example, when designers interact with users during the voice

of the customer or prototype testing, they have to evaluate if users are able to understand and process information, and if they are volunteering for research without coercion, manipulation, or undue influence from others. This happens because among medical device users are vulnerable subjects, that is, individuals with limited capacity or voluntariness such as children, people with special needs, and individuals with incurable/fatal diseases or going through emergency situations.

The absence of regulations to guide companies to develop their advertising is another ethical challenge for manufacturers: in the one hand, it is immoral to impose product, but companies have to teach physicians to use their products and need their feedback to understand the problem and development future versions.

The basic principles of ethics presented here help to define a behavioral code of conduct that can be used to support decision making when such conflicts occur. Nonetheless, associations such as AdvaMed, MEDEC (Canada's Medical Device Technology Companies), or TÜV Rheinland have code of ethics on interactions with healthcare professionals (AdvaMed 2009; BSI et al. 2011), namely gifts, product training and education, consulting arrangements, and research grants. To address the situations that are not mentioned in the codes, it is possible to resort to variant of the Bolam test, i.e. ask a responsible body of colleagues if they would support the decision.

2.13 Product development

Most innovations in the medical device sector come from universities. There are several anecdotal stories of academic assignments that lead to spin-offs that, a couple of years later, were bought by big companies that released new versions of the devices. In fact, the development of new medical devices is typically incremental with each model slightly different from the previous generation (Altenstetter 2003). Between each launch, companies analyze the performance of their products and improve them considering the user's feedback, new technologies, and manufacturing processes. Notice that, as the development time of medical devices is short, product iterations become essential.

More often than not, medical devices are invented and their development, which is heavily influenced by regulatory requirements and business considerations, is considered both capital and technologically intensive.

Medical devices rely on technologies such as material sciences, electronics, molding, and precision machining. The development of medical devices requires highly qualified personnel with different backgrounds ranging from physicians to engineers. This is particularly challenging because each professional group has its own jargon that can hinder communication. Furthermore, there are several reports of lack of close and efficient collaboration and cooperation; for instance, physicians are not interested in knowing every technical aspect of the device while designers seek only a superficial knowledge of the medical condition (Arntzen-Bechina and Leguy 2007).

It is often the case that design requirements are incomplete, complex and result from ambiguous situations. Thus, in order to have a complying product, the cost and complexity of the device can be

high. An example is the treatment of aortic aneurysms with endovascular aneurysm repair (EVAR); currently, there is little information about what happens inside the aneurysm sac after the introduction of stent-grafts, hence, the direction to follow in the design of better stent grafts is uncertain.

The healthcare sector is dynamic with research happening in every direction. This must be considered during the development and introduction in the market of a novel device because such research can lead to a new competitor treatment jeopardizing the success of the device being developed. One should also consider the innumerable stakeholders, especially healthcare policy makers, because they have multiple and (sometimes) conflicting interests that affect the device's adoption and, consequently, the manufacturer's revenues.

Figure 2.12 shows the typical lifecycle of a medical device that is included in the standard AAMI HE 75 (AAMI Association for the Advancement of Medical Instrumentation 2009). The knowledge of the lifecycle, i.e. the consecutive and interlinked stages of a device, from raw material acquisition or generation from natural resources to final disposal, is important to help designers to develop devices that are safe, effective, and efficient to use in every phases of their lifecycle. A good understanding of the device's solicitations allows better designs. For example, by recognizing that a device has to be stored for a long time before its use, influences the best before date.

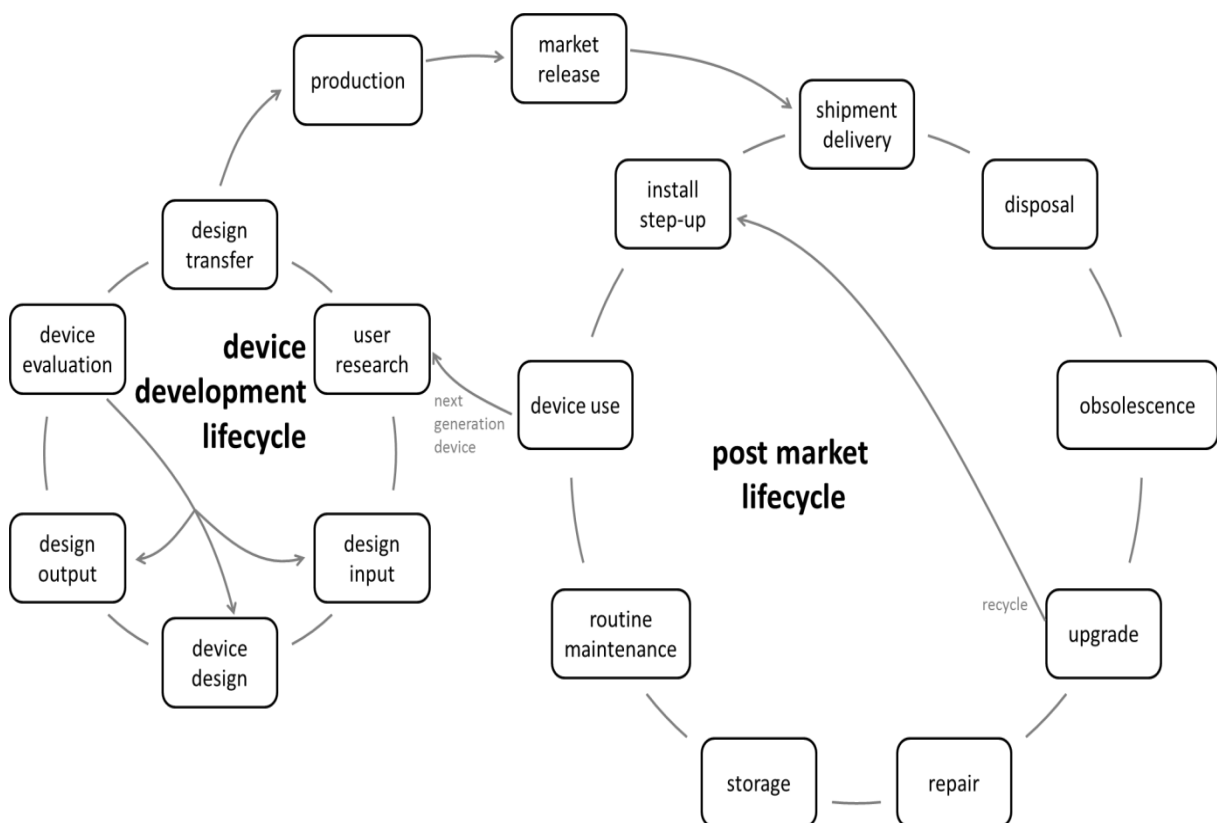

Figure 2.12: Typical lifecycle of a medical device (adapted from (AAMI Association for the Advancement of Medical Instrumentation 2009)).

Figure 2.13 represents a typical lifecycle of a medical technology according to the extinct Office of Technology Assessment (Office of Technology Assessment 1982). This type of information is crucial to support decisions regarding planning, investments, and others (Ison 2000).

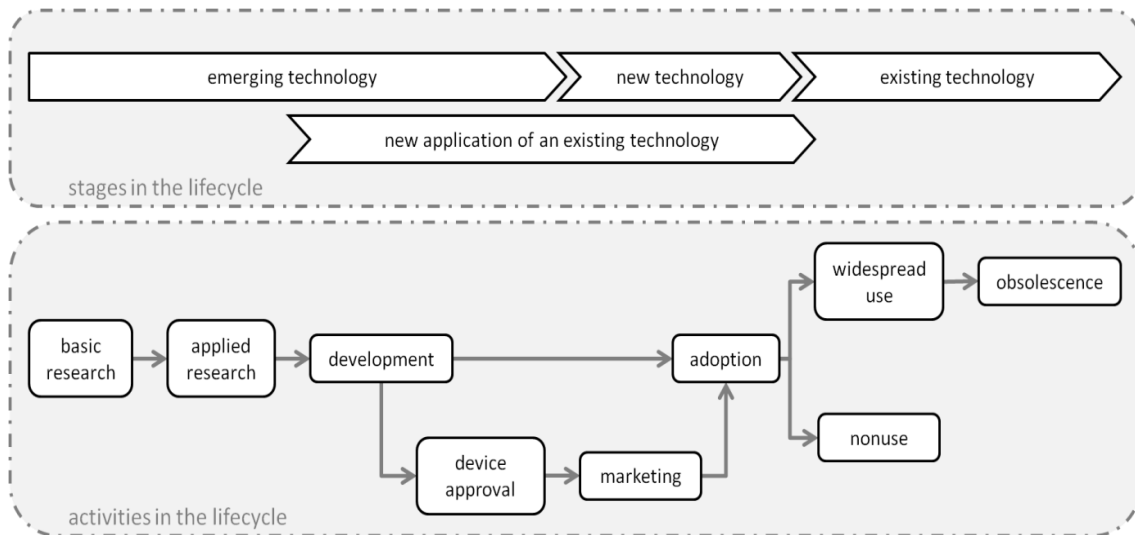

Figure 2.13: Typical lifecycle of a medical technology (adapted from (Office of Technology Assessment 1982)).

2.14 Redesign

Redesign refers to the process of designing something again or in a different way. It includes some of the same tasks as an original design, such as gathering customer needs, concept generation and prototyping, but it starts with an emphasis on reverse engineering, i.e. the observation, disassembly, analysis, testing, and documentation of a product in terms of its functionality, form, physical principles, manufacturability, and assemblability (Otto and Wood 1998). It can be a good way of developing a new product since it allows to reuse knowledge and machinery thus reducing the development time and costs.

A redesign can either be simple and subtle, or alter completely a product. There are several justifications for it, for instance, it is part of the growth strategy of a company, it aims to homogenize a heterogeneous product portfolio into a family of products (Salhieh 2007), simplify manufacture, use less expensive materials, improve the product's usability and minimize errors or extend its shelf life, strength, and durability (Figure 2.14).

In the medical device sector, redesign is part of most companies' growth strategy. In fact, companies launch their products with the assumption that further refinements will be incorporated in subsequent versions to keep customers excited about the devices and to overcome both time and technological constraints. Redesigns allow companies to gain market share while further research and development are still being carried out.

2.15 Medical device users

During product development, it is commonly accepted that the involvement of customers contributes to successful products, i.e. products that accomplish a desired aim, are known by the

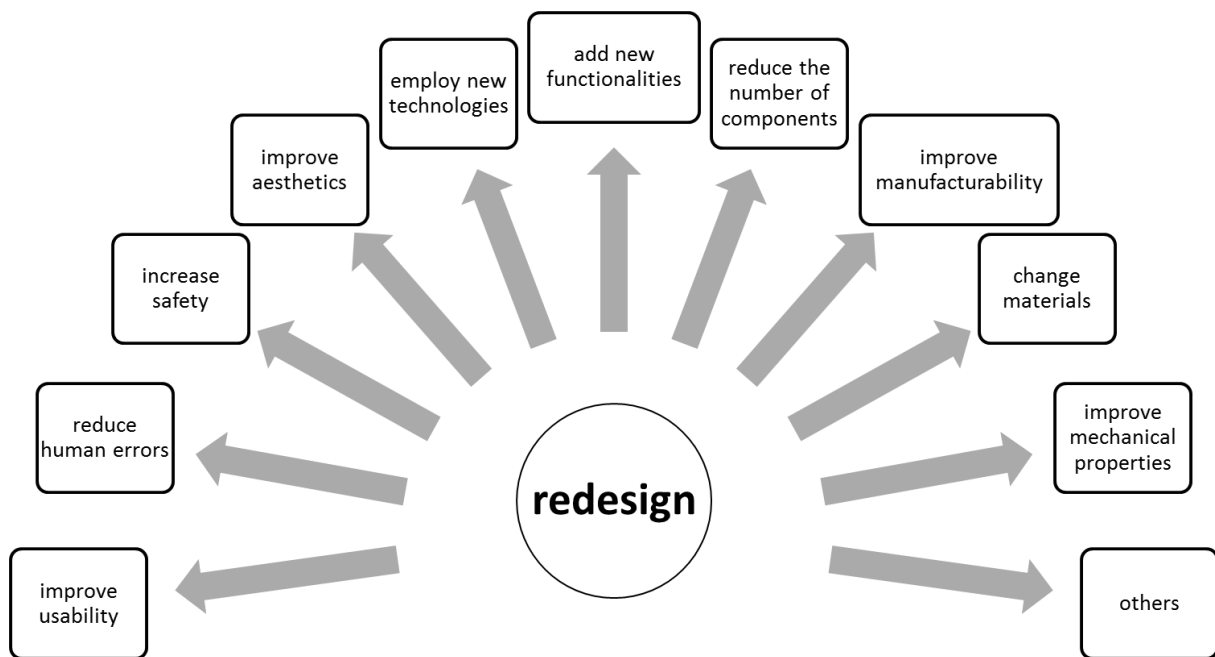

Figure 2.14: Common reasons to redesign a product.

target audience, and lead to growth and shareholder value. In fact, several tools such as quality function deployment (QFD) (Chan and Wu 2002; Sharma et al. 2008) and the Kano model (Sharif Ullah and Tamaki 2011) have been developed to identify customers' needs and demands, and translate them to design targets. In the healthcare sector, users play an equality important role (Shah and Robinson 2007) and those tools are also applied (Martin et al. 2006; Shah et al. 2009). However, special attention must be given to the fact that, in this sector, there are multiple users that, besides having distinctive perspectives of the devices, use them differently and with dissimilar expectations (Figure 2.15). Furthermore, since devices are frequently bought on behalf of the end-user and the end-user is not directly responsible for the payment of the device or treatment it is important to define the terms 'customer' and 'user'.

Customer can be defined has a person or company that purchases goods or services independently of benefiting from them. In their work, Shah et al. (Shah and Robinson 2008) presented a definition and a classification of medical device users; these authors distinguish 'medical device user' from 'medical device end-user'. The first refers to 'a person who uses a medical device for the treatment and/or care of him- / her-self or someone else', while the latter refers to 'a person who is the ultimate beneficiary of the usage of a medical device and who can also be the user of a medical device if using the medical device for him- / her-self'.

In order to involve both users and customers in the development of novel devices it is necessary to engage and communicate with them. Although this self-evident point appears to be a trivial task, it may reveal itself extremely complicated due to numerous barriers, such the diversity of stakeholders or ethical and research governance procedures. Other aspects that must be considered are the users' availability, training, technological knowledge, and also jargon.

During the identification of the users, it is important to understand the context in which the devices will be used, the cultural and anatomical differences as well as behavioral changes that may

occur. Notice that, each healthcare professional has its own practice and patients are unique (anatomy, physiology, environment, activity, and others).

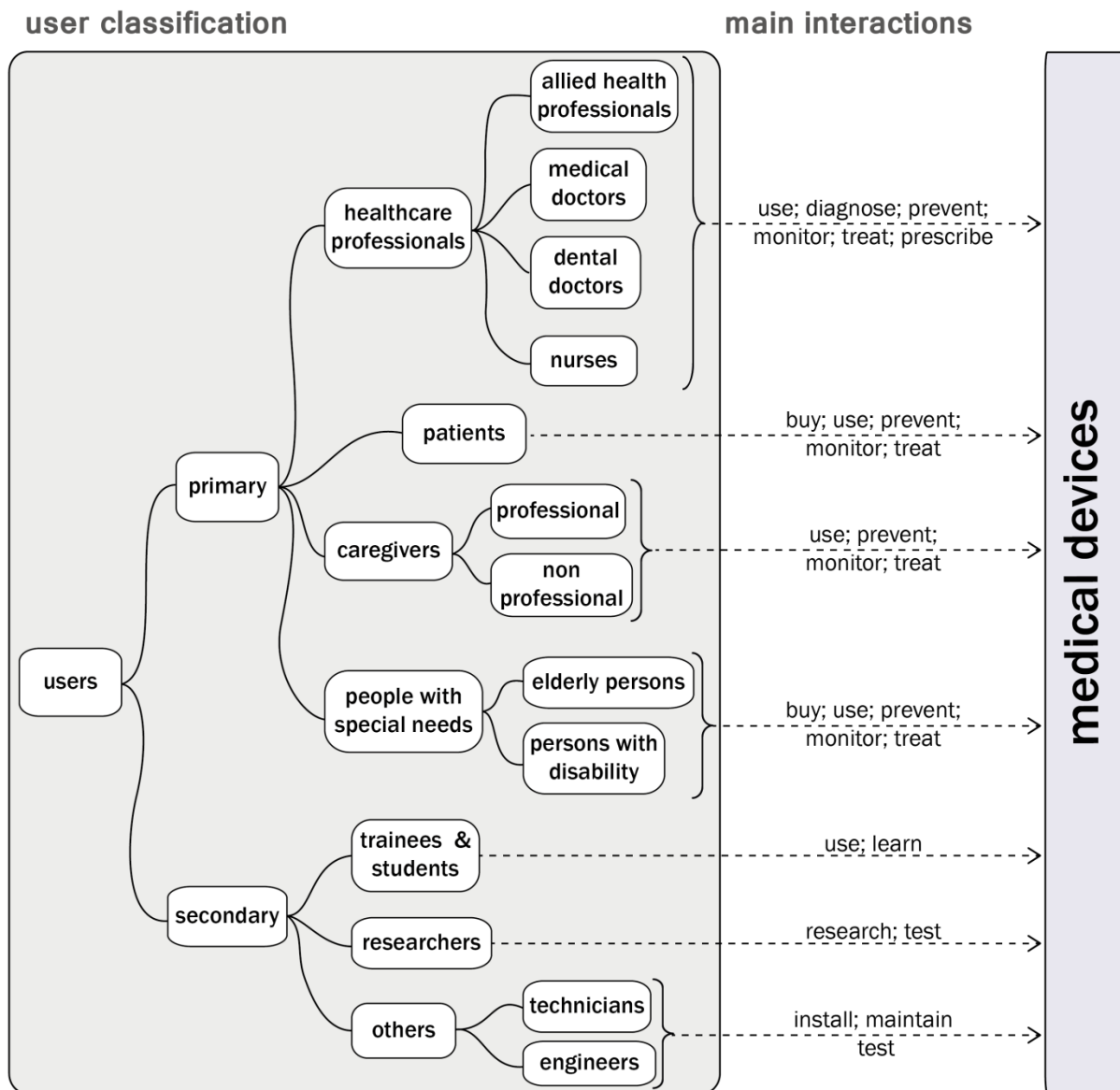

Figure 2.15: Medical device users (adapted from (Shah and Robinson 2008)) and their main interactions with the devices.

The fact of the user not being the payer not only affects the relation customer-manufacturer but also impacts the device's adoption. Regarding the first, the manufacturer may face difficulties identifying the users' needs and the environment in which will be used and, in addition, cannot estimate the device's value and the customers' willingness to pay.

2.16 Medical devices vs Drugs

Like drugs, medical devices contribute to better quality of life and are essential for effective prevention, diagnosis, and treatment of illnesses and diseases. In spite of both being part of modern

healthcare, they have several differences. In fact, the major difference between them lies in the definition itself: drugs achieve their principal intended action in or on human body by pharmacological, immunological, or metabolic means while medical devices do not. Drugs are molecular-based compounds that are administered by dose and interact with patients directly, while most medical devices are engineering-based objects that typically interact with patients through an intermediary – the healthcare professional. The mechanism of action of devices is usually well understood and produce mainly local and physical effects on the body rather than systemic and pharmacological (Linehan et al. 2007).

Drugs are discovered (science based) while devices are invented often with the involvement of physicians (hands on problem solving). Figure 2.16 shows typical product life cycle curves for medical devices and drugs; while the development of a medical device takes between 1 and 3 years, the development of a new drug takes around a decade to conclude (Cookson and Hutton 2003). However, once its safety and efficacy are determined, it remains unaltered for decades (e.g. aspirin). On the other hand, medical devices have faster cycle times and are characterized by incremental improvements; that is, the information on performance, safety and efficacy gathered by the early versions is used to upgrade the following generations.

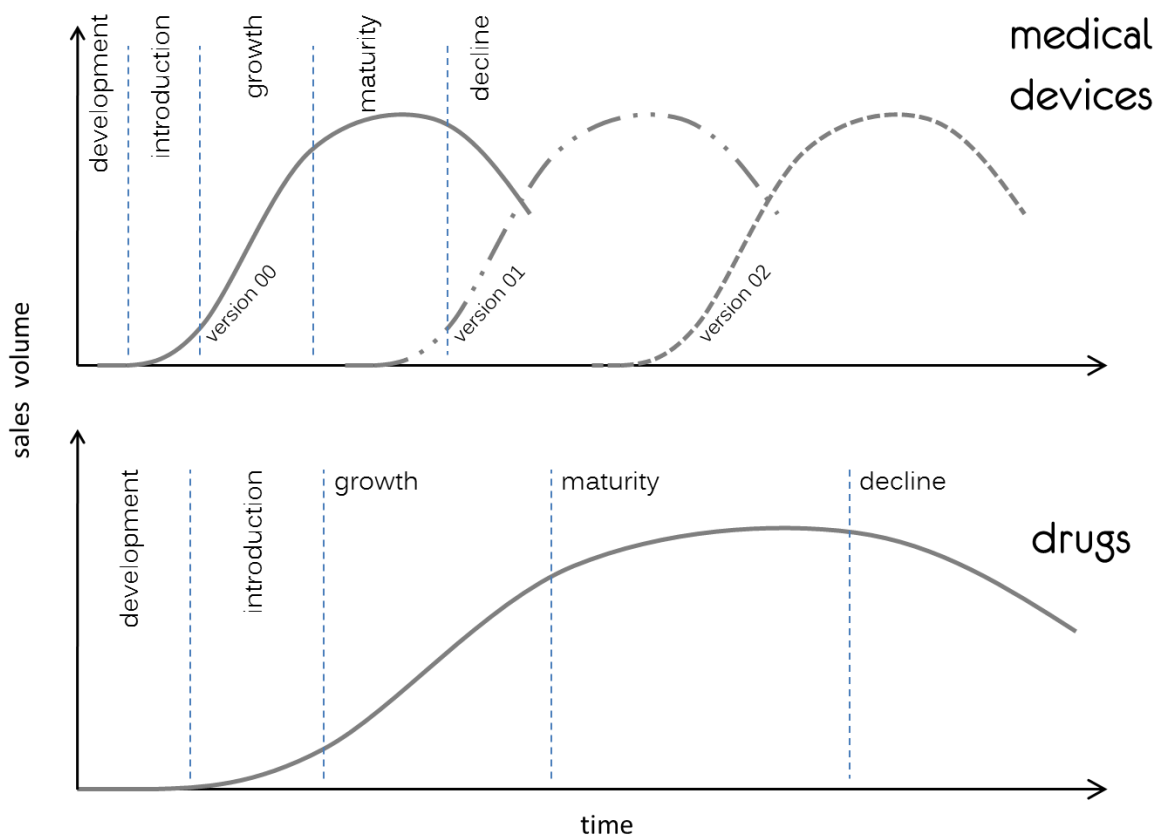

Figure 2.16: Typical product life cycle curve for medical devices and drugs.

Drugs are produced in large quantities, and thus the process can be automatized; the manufacture of devices typically requires human involvement, and many products are custom made (e.g. lower limb orthoses).

Regarding clinical trials, the methods used to access the quality, safety, and efficacy of

pharmaceuticals is inadequate for testing medical devices; it is difficult to have placebo controls for most devices or double-blind patients and physicians regarding who is getting which technology. In addition, the size of target populations for many devices makes impractical to conduct randomized clinical trials (Hanna et al. 2001).

As far as legislation is concerned, there are also differences. The legislation for drugs was created in a response to tragedies during the 1930s in the USA (the sulfanilamide incident) and the 1960s in Europe (the thalidomide tragedy). The legislation for medical devices appeared in the 1970s in the USA and in the 1990s in Europe. Drugs have been subject to internationally agreement upon methods and research protocols for decades; regarding medical devices a consensus is yet to be reached. While drugs have one regulatory program (in each country or economic region), medical devices are classified according to the risk they pose, and have to follow distinct regulations accordingly.

Concerning supply, both drugs and medical devices need a supply chain. However, there is no well-defined supply chain or profession, such as pharmaceuticals, involved in the supply of medical devices.

Payers have different expectations from drugs and devices: they demand a higher level of efficiency of drugs, while with medical devices, they care about effectiveness. When conducting health technology assessment, one also finds differences between the two (Drummond et al. 2009; Sorenson et al. 2011), for example, devices frequently undergo modifications which may impact on efficacy and cost.

Medical devices vary in size, durability (from disposable to implantable), complexity, packaging, and use. Their performance depends on the device itself and how it is used. Many devices require service and maintenance while many others are dependent on infrastructure and therefore, being difficult to use in low-resource settings or being reserved to financially privileged patients.

Adequate and/or device-specific training are often required for medical devices and, sometimes, the learning curves of these products can be long.

Comparing both industries, the pharmaceutical industry requires high capital and is considered a powerful force while the medical device sector requires considerably less capital, is recent and composed by smaller companies.

2.17 Chapter takeaways

Overall, the term ‘medical device’ refers to any apparatus, software, material, or other similar or related item intended to be used in the diagnosis, prevention, monitoring, treatment or alleviation of a disease or an injury. Although it encompasses a wide range of products, it is possible to identify a set of features that distinguish them from other products. These features are listed below.

- The exact definition of the term ‘medical device’ varies from country to country along with the corresponding regulatory framework.

- Medical device regulations are recent.
- Medical devices are progressively regulated considering their complexity and associated risks.
- In order to comply with regulations, medical devices must follow standards and guidelines regarding quality, safety, effectiveness, and other topics.
- There are multiple classifications for medical devices; while some are academic, others impact the device's lifecycle, such as the risk classification.
- The absence of standardized nomenclatures and procedures creates confusion, extra work, and costs for manufacturers.
- Each country (or economic region) has specific rules to allow the commercialization of a medical device.
- After a device is in the market, manufacturers have two obligations: post-market surveillance and adverse event reporting.
- In case of a defect or a possible defect of a medical device, its manufacturer or distributor may take actions to recall or correct the device. The recall procedures may vary from country to country.
- The medical device market, in spite of being highly regulated, is dynamic and in continuous growth. In addition, it is characterized by the uncertainty of one not knowing when will be sick and which device will need.
- Medical device industry is highly fragmented and consists of small niche markets with few products.
- The diffusion and adoption of medical devices go beyond science as they also involve ethics and economics.
- Each entity, country and economic region has specific rules to determine the coverage and reimbursement of a medical device.
- There is a constant potential for ethical conflicts in the development of medical devices. In an early stage, it is important to define a set of basic principles to follow and guide decision making.
- The development of medical devices is typically incremental and involves highly qualified personnel with different backgrounds.
- In the medical device industry, as well as in healthcare, price is a sensitive topic.
- Medical devices have multiple users that, besides having distinctive perspectives of the devices, use them differently and with dissimilar expectations.
- Although medical devices are used in the prevention, diagnosis, treatment of illnesses and diseases like drugs, they have numerous differences.

Some features described here are not exclusive to medical devices. However, taken all together, they suggest that the medical device industry is complex and would benefit from a dedicated product development methodology to guide the development process.

By incorporating these features in the development process, it helps to define the objectives and procedures to achieve them, and supports decision involving trade-offs between conflicting requirements. In addition, it ensures that projects are managed within budget and schedule avoiding surprises, and the consequent ripple-effect rework.

Overall, a dedicated product development methodology would minimize the chances of a commercial flop, i.e. products that do not accomplish the desired aim, are unknown by the target audience, and lead to economic losses, and contribute to cost savings and the launch of new products more quickly, effectively, and efficiently.

3 Methodologies for the development of medical devices

3.1 Introduction

Product development is a process in which an individual or an organization transforms an idea into a product or a service and launches it into the market. This process, along with innovation, is pointed out as an essential tool for companies' growth and differentiation from the competition (Holtzman 2008).

Even though each new-product development process is unique, the processes share common tasks and features. Thus, it is possible to define a generic procedure and apply it to the development of disparate products such as medical devices and household appliances. The application of such a procedure has manifold advantages; to name just a few, it facilitates planning, increases predictability, helps to improve quality, reduces costs, and compresses cycle times (Owens and Cooper 2001; Sheridan 2003). On the other hand, a dedicated procedure, one that considers the characteristics of the product being developed and the environment in which that development occurs, can provide additional benefits (Charnley et al. 2011). Along this chapter, process modeling is discussed as well as the modeling of product development processes. In addition, the existing product development methodologies dedicated to medical devices are reviewed.

This chapter contains work and results presented in the article 'Modeling of the medical device development process' by Isa C.T. Santos, G. Scott Gazelle, Luís Rocha, and João Manuel R. S. Tavares, published in the September 2012 issue of the journal 'Expert Review of Medical Devices'.

3.2 Process modeling

'Process' refers to a sequence of steps or actions taken to achieve a particular end. Examples of processes are the sequence of steps taken to make a doctor's appointment, the sequence of activities carried out to develop a new product, or even the sequence of steps to produce a chemical compound.

Process modeling refers to the activity of representing processes; that is, the description of sequences of activities to achieve a specific end. Process models are developed for several reasons, namely to learn about the process itself (e.g. which activities have to be carried out), predict behaviors and/or outcomes (e.g. the duration and/or the cost of a project), and suggest ways to control it. These models can either be descriptive or prescriptive.

A descriptive or explanatory model describes and explains why and how a process works or occurs in a certain way. In comparison, prescriptive models, which are also known as normative ones, describe how processes should, could or might be performed by following rules and guidelines that can range from strict to flexible in order to obtain a specific performance.

In order to determine the strengths and weaknesses of each model, users can judge different criteria. Smith et al. (Smith and Morrow 1999) judge the predictive value of a PDP model assessing if it addresses important managerial issues, e.g. task scheduling, resource allocation, target specification, or others. They also question the information used in decision making, that is, if the information is credible and available in a timely manner. The rigor, the assumptions and the simplifications along with the model’s computational tractability (i.e. existence of commercial software that is crude and user-friendly) are considered as well. In their review work on PDP models, Sharafi et al. (Sharafi et al. 2010) compared the degree of resolution, i.e. the detail used in the description of the activities and how tasks were represented. In addition to the criteria presented by these authors, one can also assess the model’s applicability, practicability, coherence, easiness (i.e. complexity of creating models), and ability to be easily apprehended by laypersons. The model’s efficiency, effectiveness (if achieve its goals), and completeness (if all concepts are represented) should be evaluated as well.

Much of a process model’s coherency and intelligibility comes from its notation. Thus, most authors prefer to use standard modeling languages, either textual or graphical. In the literature, it is possible to find a large number of modeling languages; Table 3.1 summarizes, in alphabetical order, the graphical process modeling languages most commonly used in the representation of the development process of medical devices, and provides references for further reading.

Table 3.1: Process modeling languages.

Language	Description	Further reading
BPMN – Business Process Modeling Notation	It is a standard, graphical modeling representation for business processes; it was specifically designed to coordinate the sequence of processes and messages that flow between different process participants in a related set of activities. The notation used is independent of the implementation environment.	(White and Miers 2008)
Flowchart	It is a diagrammatic representation that presents a step-by-step solution to a given problem. Process operations are represented by different boxes that are connected by arrows representing the process’s flow.	(Madison 2005)
UML – Unified Modeling Language	It is a visual modeling language used to specify, visualize, construct, and document artifacts of a software system. It is intended to be supported by interactive visual modeling tools that have code generators and report writers.	(Rumbaugh et al. 1999)

The selection of the language to be used is strategic since each language stresses different aspects of the processes, namely: activity sequencing, resource allocation, communications or organizational responsibilities.

3.3 Modeling of the product development process

The new-product development process aims to be a recipe to create products, but it can also support the transition between scientific research and the market, i.e. cross the ‘valley of death’

(Figure 3.1). Typically, new-product development is considered a complex process because it addresses a wide range of technical issues, involves varied people and organizational structures, and sometimes the involved dependencies are unclear. In addition, it is unique and repetitive: on the one hand, it is unique because it does something new just once, and on the other hand, it is repetitive because many steps can be repeated in the development of other products (Smith and Morrow 1999). The outputs of many product development activities are difficult to measure, and cannot be verified until much later (Browning et al. 2006). Activities, besides being nonlinear, iterative, and tend to occur in parallel, also involve creativity and innovation, two issues that many believe to be impossible to systematize in spite of the innumerable publications stating otherwise (Puccio et al. 2010; Smoot and Strong 2006).

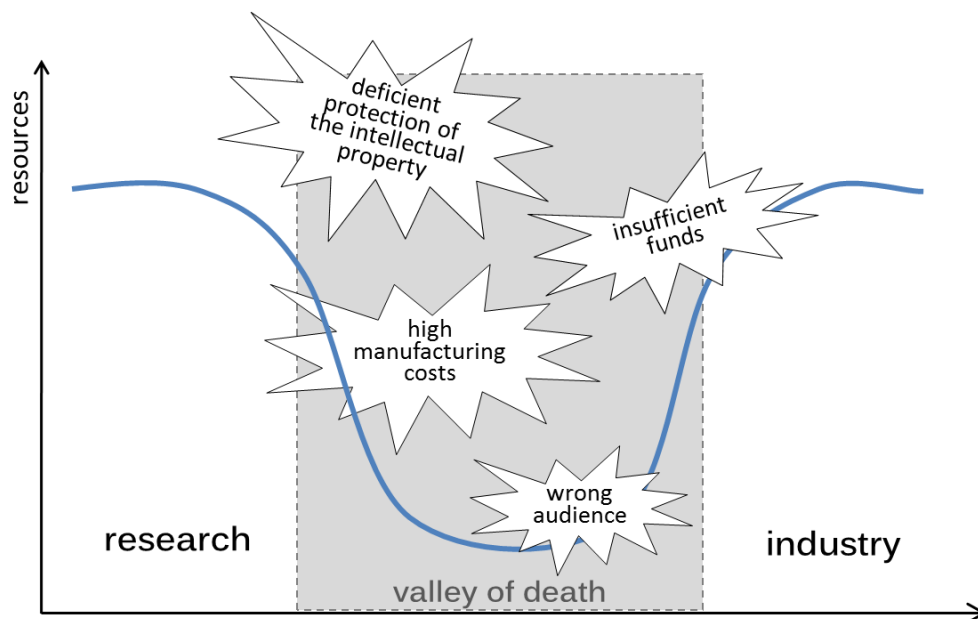

Figure 3.1: Representation of the valley of death and some of reasons for falling on it.

In the literature, there are several representations of the new-product development; while some are detailed, often being the starting point of management activities, others have little practical use but provide a conceptual framework. There are also some representations that offer both. Following, some examples are given.

Among the representations based on mental concepts, or conceptual, there is the one described by Barclay et al. (Barclay et al. 1994), which defines the development process as a collection of wedge-shaped mini-processes in which there is a need to concentrate more efforts in the early stages. The representation given by Ulrich et al. (Ulrich and Eppinger 2011) shows the evolution of the number of concepts during the process (i.e. several concepts converging to a single product), while the spiral adopted by Barry Boehm (Boehm 1988) illustrates the iterative nature of product development (Figure 3.2).

Besides conceptual representations of the new-product development, in their book, Ulrich et al. (Ulrich and Eppinger 2011) present several flowcharts and block diagrams that can help managers and/or designers to identify the tasks to be completed. Kotler et al. (Kotler and Keller 2012) also use flowcharts to describe the multiple activities of the development process, but they adopt the point of

view of a marketing team (Figure 3.3). Fairlie-Clarke et al. (Fairlie-Clarke and Muller 2003) reviewed the literature to identify the requirements that a model of new-product development activities should satisfy and proposed a new one using an integration definition for function modeling (IDEFO) structure. The representation adopted by Cooper et al. (Cooper 2008; Cooper 1990), the stage-gate model, not only enumerates the tasks to be completed but also identifies decision points (Figure 3.4).

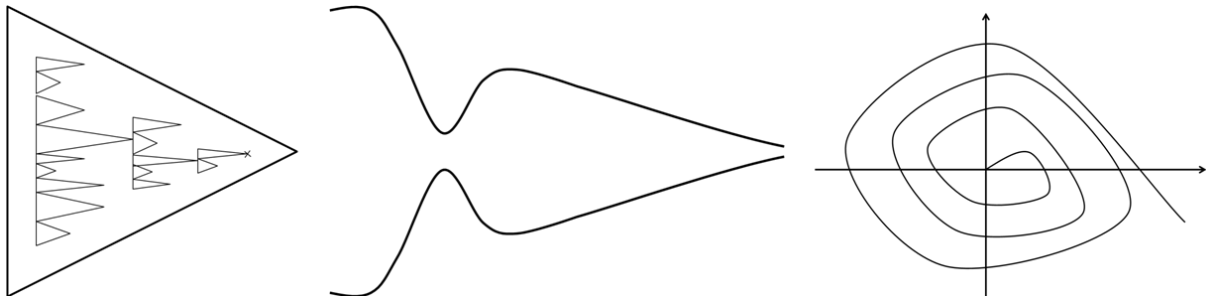

Figure 3.2: Conceptual representations of the product development process: on the right, the model suggested by Barclay et al. (Barclay et al. 1994), in the center, the one suggested by Ulrich et al. (Ulrich and Eppinger 2011) and, on the left, the model presented by Barry Boehm (Boehm 1988).

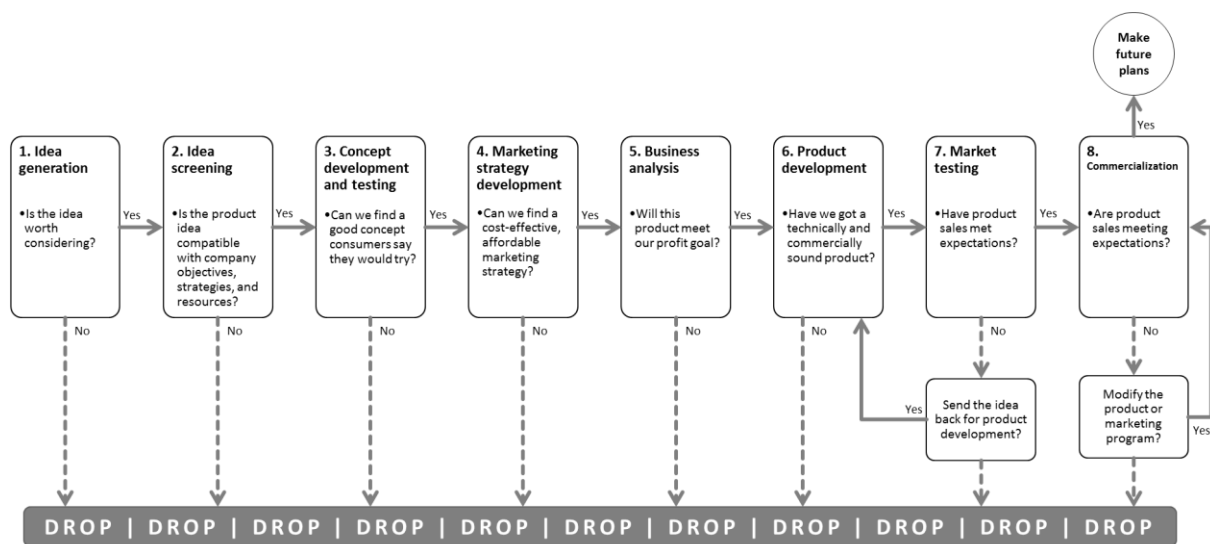

Figure 3.3: The new-product development presented by Kotler et al. (Kotler and Keller 2012).

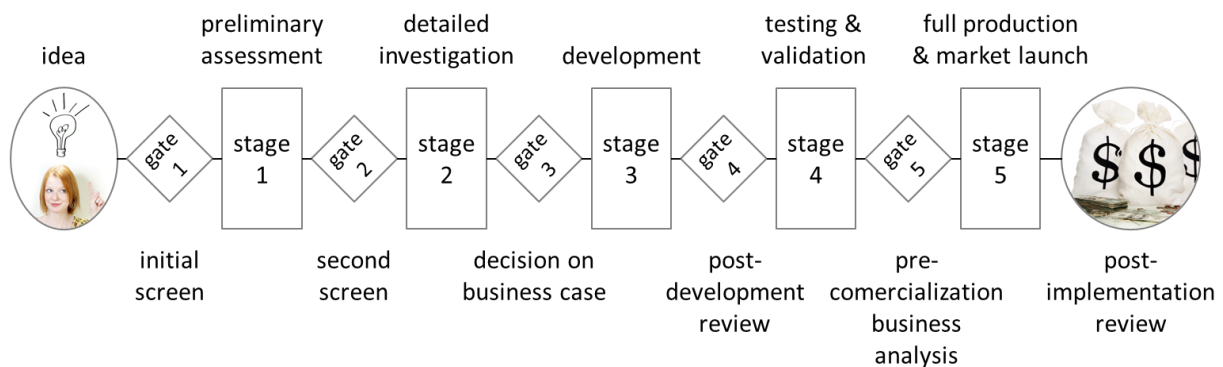

Figure 3.4: The stage-gate model presented by Cooper et al. (Cooper 2008; Cooper 1990).

The information generated during the development of a new product is huge. Furthermore, it has to be accessible to every team member wherever they are. In order to meet this need, some web-based tools have been proposed; Volpentesta et al. (Volpentesta et al. 2004) studied this problem

and proposed a logical model which can drive the conception of tools for supporting the distributed management of design data of mechanical products.

Quality function deployment (QFD) is a customer-oriented quality management and product development technique that can be applied either to products or services (Chan and Wu 2002; Sharma et al. 2008). This technique uses the representation of the house of quality (HoQ), to integrate the voice of the business, the customer, and the engineer quantifying the relationship between inputs and actions, i.e. trade-offs (Park and Kim 1998) (Figure 3.5). Hence, it can be used as a management tool to evaluate the impact and the value of different technical concepts.

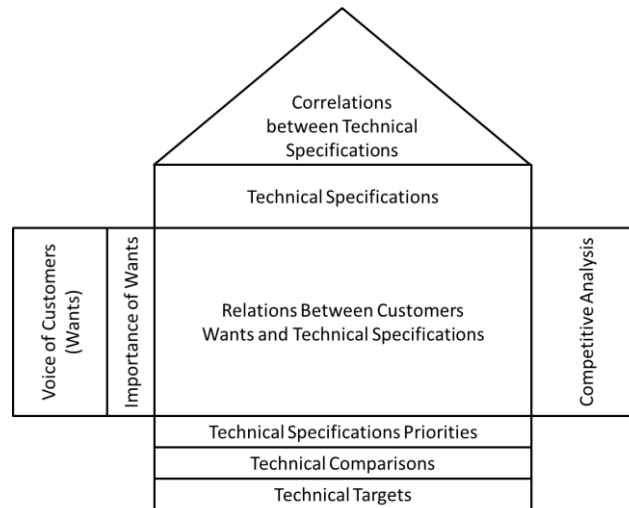

Figure 3.5: The house of quality (HoQ).

The implementation of Lean Techniques can be resumed in 5 steps: (1) specification of the value from the standpoint of the customer, (2) identification of all steps in the value stream and elimination of the ones that do not create value, (3) execution of the value-creating steps in a tight sequence, (4) make customers pull value from the next upstream activity, (5) repetition of steps one to four until achieve perfection. These techniques can be applied to NPD as well (Oppenheim 2004). In this case, process modeling is essential to visualize the process, analyze the flow, and signal the activities that add value and the ones that do not; it also indicates the duration of the project by measuring the lead time (Figure 3.6).

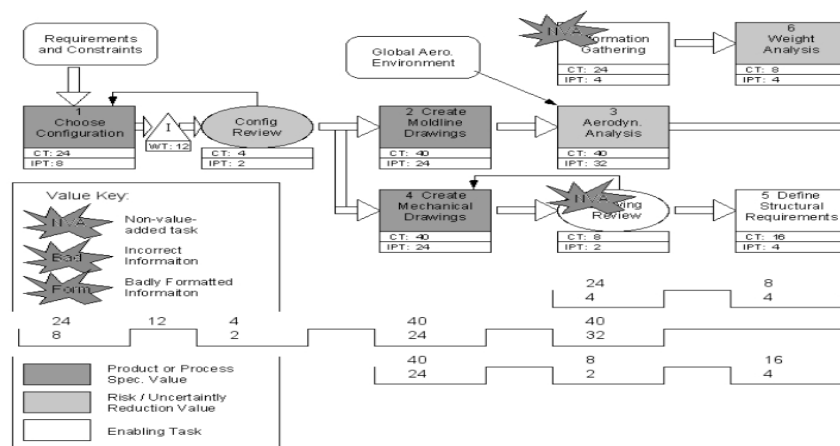

Figure 3.6: Value stream map of a product development process (adapted from (Mcmanus 2005)).

3.4 Modeling of the medical devices development process

The development process of medical devices, in addition to the complexities mentioned in the previous section, has particularities on its own that should be considered. To accommodate such particularities, several authors studied medical devices and their development process, and proposed dedicated methodologies and process models.

In order to identify relevant publications on the development process of medical devices was performed a literature review during February and April 2012. The databases ENGINEERING VILLAGE and SCOPUS were explored to identify articles, conference papers, and reviews; the search was limited to manuscripts to which the authors had full access to and were published in English between 1995 and 2012. For each database, a first selection was accomplished considering the titles and the abstracts of the publications; the articles addressing the DPMD, as a whole or part, were included. In a second stage, the duplicated titles were excluded, and the full texts were analyzed; only the publications that included a model addressing, in a whole or part, of a general DPMD or of a subgroup of medical devices was included. Further searches were conducted in the World Wide Web using the search engine Google to identify books, standards, and publications from governments and regulatory authorities. Figure 3.7 shows graphically the methodological framework for literature searching and retrieval as well as the inclusion and exclusion criteria.

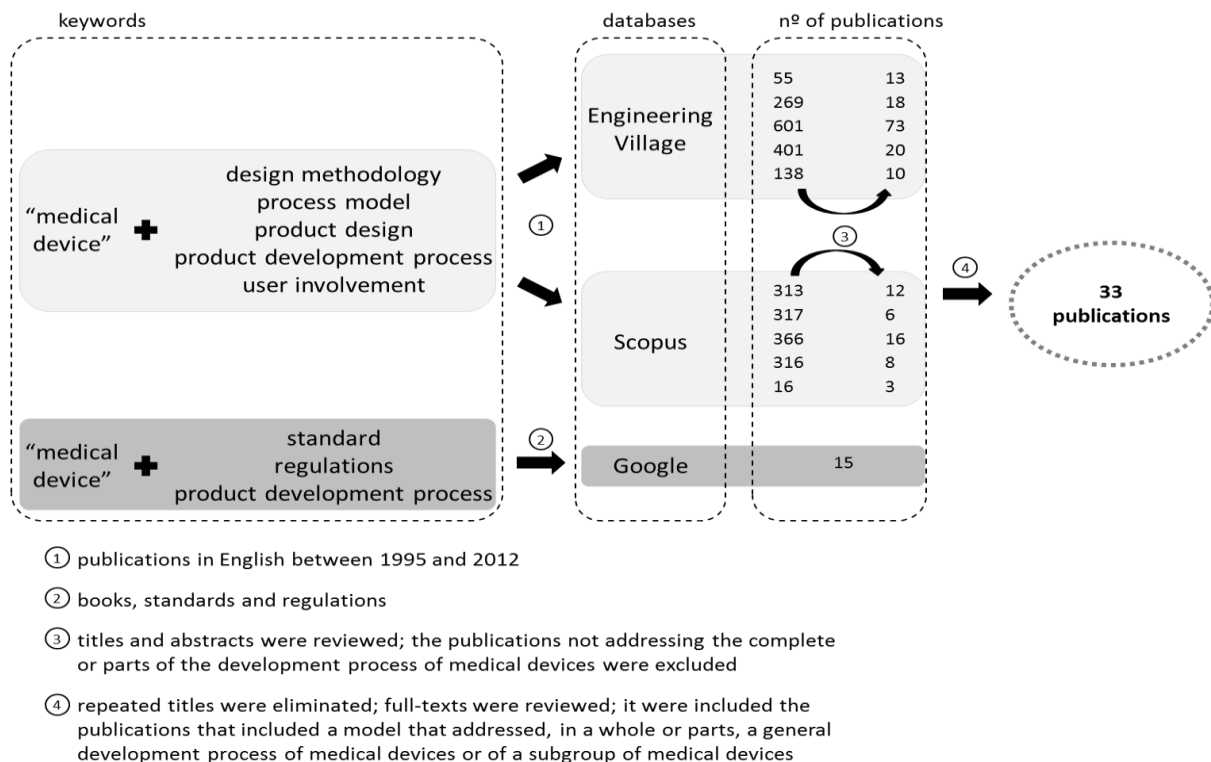

Figure 3.7: Methodological framework for literature searching and retrieval of relevant publications on the development process of medical devices.

The publications addressed throughout this study are indicated in Table 3.2; this table also includes a summary of the publication, the model’s possible applications, and the modeling language adopted.

Table 3.2: Documents included in the literature review; model's possible use and modeling language adopted.

#	Author(s)	Year	Title	Summary	Possible applications							Modeling language						
					Process mapping	Process management	Product characterization	Support to decision making	Risk management	quality management	information management	Text	Flowchart	Block diagram	BPMN	UML	Other graphical representation	
1	Aguwa et al. (Aguwa et al. 2010)	2010	Integrated fuzzy-based modular architecture for medical device design and development	This paper presents an integrated collaborative modular architecture method for medical device design and development focused on analyzing the input of stakeholder data from existing products and components.			x				x		x					x
2	Aitchison et al. (Aitchison et al. 2009)	2009	A review of the design process for implantable orthopedic medical devices	This paper presents an overview of the design process for implantable orthopedic medical devices.	x								x					x
3	Alexander et al. (Alexander and Clarkson 2002)	2002	A validation model for the medical devices industry	To encourage an integrated approach to design, development and validation, the paper adapts the V-model to the design of medical devices.		x			x	x			x					x
4	ANSI/AAMI HE 74:2001 (AAMI Association for the Advancement of Medical Instrumentation 2001)	2001	Human factors design process for medical devices	This standard describes a human factors engineering process aimed to fulfill the user interface design requirements in the development of medical devices and systems.			x				x		x					x
5	ANSI/AAMI HE 75:2009 (AAMI Association for the Advancement of Medical Instrumentation 2009)	2009	Human factors engineering — Design of medical devices	This standard provides human factors design principles for medical devices. It also includes a graphic representation of the medical device's lifecycle.		x	x				x		x					x

#	Author(s)	Year	Title	Summary	Possible applications						Modeling language					
					Process mapping	Process management	Product characterization	Support to decision making	Risk management	quality management	information management	Text	Flowchart	Block diagram	BPMN	UML
6	Bradley et al. (Bradley and Teixeira 2002)	2002	Design controls for the medical device industry	This book presents examples and templates for the implementation of design control programs that meet the quality requirements.		x				x	x	x	x			x
7	Brown et al. (Brown and Motte 1998)	1998	Device design methodology for trauma applications	This paper describes the development process, namely methods to collect customer needs, of medical devices used in the trauma environment.	x		x					x		x		
8	De Rouck et al. (De Rouck et al. 2008)	2008	A methodology for shifting the focus of e-health support design onto user needs: a case in the homecare field	This paper describes a methodological model to incorporate user perspectives in the design and development process of e-health systems.	x		x					x				
9	El-Haik et al. (El-Haik and Mekki 2008)	2008	Medical device design for six sigma: A road map for safety and effectiveness	This book describes the development of medical devices using the Design for Six Sigma philosophy.	x	x			x	x		x		x		x
10	FDA (FDA 1997)	1997	Design control guidance for medical device manufacturers	This report provides guidance to manufacturers regarding the requirements of the FDA's quality system.					x	x		x	x			x
11	Fries (Fries 2001)	2001	Handbook of medical device design	This book reviews of regulatory and standards issues in the design of medical devices.			x		x	x		x		x		
12	Fries (Fries 2006)	2006	Reliable design of medical devices	This book describes medical devices development processes as well as standards and regulations.			x		x	x		x		x		
13	Gopaldaswamy et al. (Gopaldaswamy and Justiniano 2004)	2004	Six sigma for medical device design	This book describes the development of medical devices using the Design for Six Sigma philosophy.	x	x			x	x		x		x		x
14	Grocott et al. (Grocott et al. 2007; Shah et al. 2009)	2007	A model of user engagement in medical device development	It presents a model of user engagement during the development of medical devices; it includes as a case study the investigation of the unmet needs of individuals with Epidermolysis Bullosa.			x									x

#	Author(s)	Year	Title	Summary	Possible applications						Modeling language						
					Process mapping	Process management	Product characterization	Support to decision making	Risk management	quality management	information management	Text	Flowchart	Block diagram	BPMN	UML	Other graphical representation
15	ISO 14971:2007 (ISO International Organization for Standardization 2007)	2007	Medical devices - Application of risk management to medical devices	It specifies a process identify hazards associated with medical devices.						x	x						x
16	Kossack et al. (Kossack and Gellatly 2007)	2007	The what and how of medical device design validation: A human factors methodology	A methodology to determine which product's requirements should be assessed to meet the requirements from FDA.			x		x	x		x					
17	Kramer (Kramer 2010)	2010	Design driven development: The D3 process	The model described by Pietzsch et al. [64] is reviewed to include tasks related with design.	x	x		x			x	x					x
18	Klein et al. (Klein and Jordan 2002)	2002	Methods of assessing medical devices	This paper presents a process for defining the frameworks in which medical devices can be assessed.		x	x		x	x		x					
19	Kriewall et al. (Kriewall and Widin 1991)	1991	An application of quality function deployment to medical device development	This paper demonstrates how QFD can be applied to medical devices.			x					x					x
20	Maisel (Maisel 2004)	2004	Medical device regulation: An introduction for the practicing physician	This paper explains the rules that govern, in the USA, the approved and unapproved use of medical devices, device premarket evaluation and approval processes and device postmarket surveillance.		x						x					x
21	MEDDEV Guidance documents (MEDDEV 2010)	2010	Medical devices guidance document - Classification of medical devices	This document explains the European risk classification rules.		x		x	x		x	x					
22	Medina et al. (Medina et al. 2011)	2011	An ontology model for the medical device product development	This paper presents an earlier version of the model presented in (Medina et al. 2012).	x						x						x
23	Medina et al. (Medina et al. 2012)	2012	Supporting medical device development: a standard product design process model	Using conceptual graphic representations, this paper presents the medical device development process and its relations with the regulations from the FDA.	x						x						x

#	Author(s)	Year	Title	Summary	Possible applications						Modeling language						
					Process mapping	Process management	Product characterization	Support to decision making	Risk management	quality management	information management	Text	Flowchart	Block diagram	BPMN	UML	Other graphical representation
24	Mehta (Mehta 2008)	2008	Commercializing successful biomedical technologies: basic principles for the development of drugs, diagnostics and devices	It describes multiple aspects of the commercialization process of drug, diagnostic and device biomedical technology.	x	x		x				x					x
25	Newnes et al. (Newnes et al. 2006)	2006	A cyclic design approach applied to a cervical screening device	This paper describes the application of a cyclic methodology to the design of a device for use in the diagnostic evaluation of cervical smears.	x		x					x					x
26	Panescu (Panescu 2009)	2009	Medical device development	This paper reviews items related to the process of designing medical devices.	x							x					
27	Pietzsch et al. (Pietzsch et al. 2009)	2009	Stage-gate process for the development of medical devices	This paper presents a model for the development of medical devices based on best-practices of USA's companies.	x	x					x	x					x
28	Privitera et al. (Privitera et al. 2009)	2009	Applied ergonomics: determining user needs in medical device design	This paper describes the methodology used by the University of Cincinnati's Medical Device Innovation and Entrepreneurship Program for determining user needs.			x					x					x
29	Santos et al. (Santos et al. 2012)	2012	The specificities of medical devices - opportunity for a dedicated product development methodology	This paper identifies the peculiarities of medical devices, including the device's path to market in Europe and in the USA.	x							x	x				
30	Shah et al. (Shah et al. 2009)	2009	Developing medical device technologies from users' perspectives: A theoretical framework for involving users in the development process	It proposes a framework for involving various types of users in the medical device technology development process.			x					x					x
31	WHO (WHO 2003)	2003	Medical device regulations: global overview and guiding principles	This book offers countries a framework within which they can plan their regulatory system for medical devices.		x						x					x
32	Zenios et al. (Zenios et al. 2010)	2010	Biodesign: the process of innovating medical technologies	This book describes the medical device development process.	x	x	x	x	x	x	x	x	x	x			x

In 2007, a research group from the Stanford University led by John H. Linehan published a report (Linehan et al. 2007) in which it was said that, in general, there was little data on the development process of medical technologies. That statement is confirmed by the research presented here (Figure 3.8). Overall, the number of publications has been increasing, and there is no trend regarding the topics addressed.

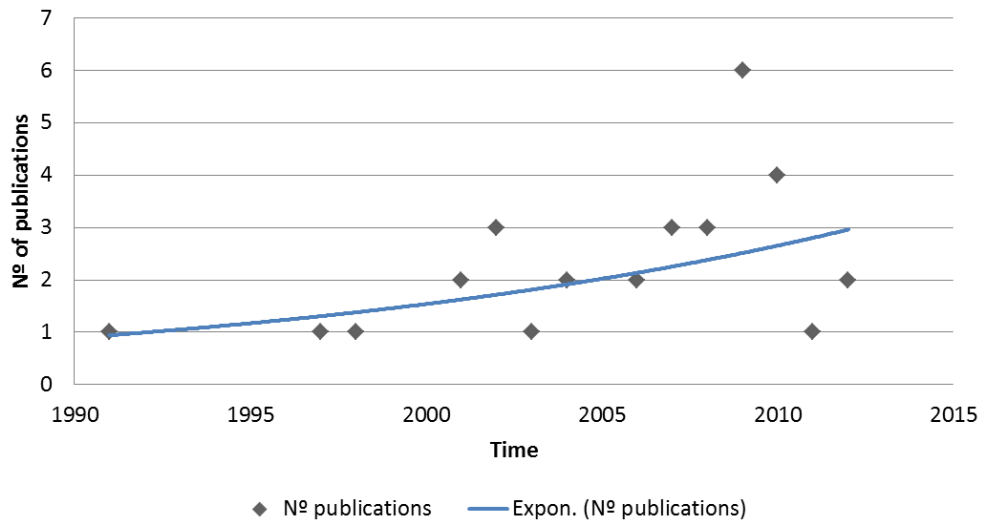

Figure 3.8: Evolution of the number of publications on the development process of medical devices.

To describe the development process of medical devices, most authors prefer to write texts and complement them with diagrams. For instance, Fries (Fries 2006; Fries 2001) uses flowcharts to describe the regulatory processes and identify the main phases of the development process (Figure 3.9); then, he suggests several questions that should be answered during each stage to support design decisions, namely trade-offs. By using words is possible to describe more complex situations and present more than one alternative clearly; however, the consultation becomes more difficult because one has to read the entire document for a correct interpretation and use.

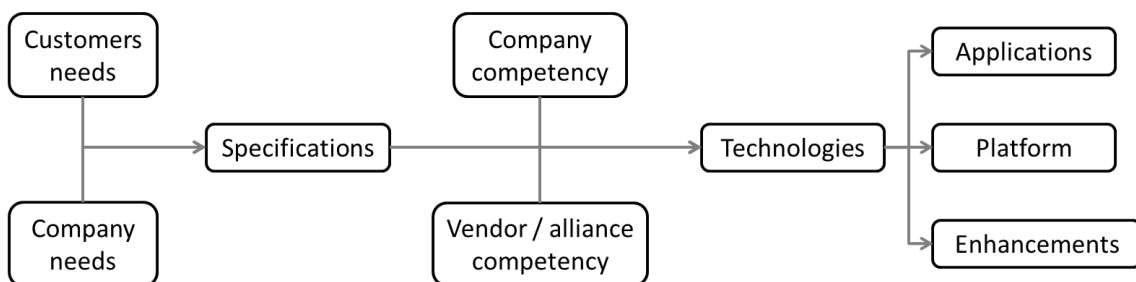

Figure 3.9: Richard C. Fries's representation of the medical device development process (adapted from (Fries 2006; Fries 2001)).

Flowcharts and block diagrams are the most common process modeling languages. There are two possible explanations for this: first, these notations are mainly used to describe the regulatory framework (e.g. Maisel (Maisel 2004) and Santos et al. (Santos et al. 2012)) which is a process that involves simple logic; and second, these languages, besides being simple, are common knowledge and authors wish to transmit their message without burden readers with having to learn another modeling language. Nevertheless, Medina et al. (Medina et al. 2012; Medina et al. 2011) present

their model using UML relationships (Figure 3.10); as the model includes captions with the meaning of the symbols used, it can be easily apprehended by laypersons.

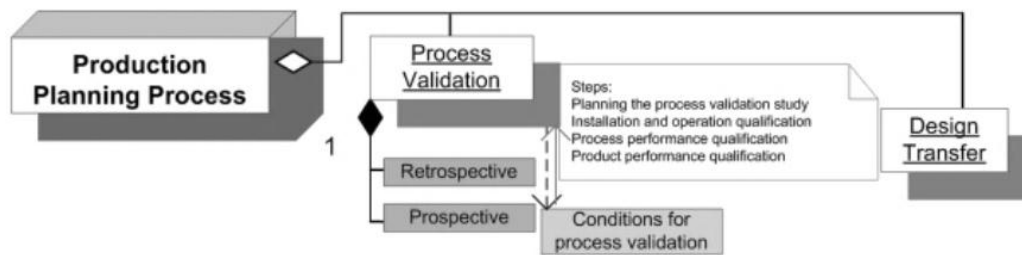

Figure 3.10: Model example for production planning process from Medina et al. (Medina et al. 2012).

Notwithstanding the multiple modeling languages, most authors resort to other types of graphic representation. For example, Bradley et al. (Bradley and Teixeira 2002) suggest the use of Gant and Pert charts to support the management of the development process, and Alexander et al. (Alexander and Clarkson 2002) represents the process as a 'V' alluding to the need of verification and validation of medical devices.

Commonly, models of the development process of medical devices are found in journals or books but, to transmit their message, the consulting firm *Clinical Device Group* (Chicago, IL, USA) (Clinical Device Group 2012) was bold adopting their own graphics and commercializing merchandise (e.g. mouse pads and circular calendars) containing relevant information to the development of medical devices, namely the definitions of 'adverse event' or biocompatibility test matrixes. In their webpage, the consulting firm *Emergo Group* (Emergo Group 2012) has available several graphics of the regulatory pathway to follow in multiple countries, specifically Japan, Canada, Australia, and others.

The British National Health Service (NHS) National Innovation Centre (NIC) has available online free-to-use tools to support the development of innovations: the 'Scorecard' (NHS National Innovation Centre 2012a) and the 'Navigator' (NHS National Innovation Centre 2012b). While the former aims to rank ideas, the latter can be used to structure the development of a novel device. According to the NIC's 'Navigator', the development of medical devices is divided into 5 phases: 'define the need', 'design the solution', 'develop the opportunity', 'demonstrate the benefits', and 'distribute the product'. For each phase are presented several tasks; each task is described and one has to answer a set of questions in order to complete it. It is also possible to consult documents and find organizations that help completing the tasks. In addition, it is possible to save ideas online and create a work plan.

The majority of the models found are descriptive and those that are explanatory aim to describe the complete medical device development process or some of its stages. Regarding the focuses of the models, they are assorted; while a large amount presents a specific topic such as the medical device's lifecycle (e.g. the standard ANSI/AAMI HE 75:2009 (AAMI Association for the Advancement of Medical Instrumentation 2009) and the WHO's publication (WHO 2003)), others are comprehensive and explain the relations between the varied actors in the process (e.g. Medina et al.'s ontology model of the medical device development process in the USA (Medina et al. 2012; Medina et al. 2011)). Another issue commonly represented is the regulatory framework, namely the regulatory routes (e.g. Maisel (Maisel 2004) and Santos et al. (Santos et al. 2012)). There also some

models that aim to help designers include in the development process the users (e.g. Grocott et al. (Grocott et al. 2007)).

Here, as far as possible uses for the models are concerned, 7 topics were identified:

1. **Process mapping** – description of the main activities to be carried out, information flows, and interconnections;
2. **Process management** – administrative activities aimed at planning, controlling, and monitoring in terms of resources, costs, and time;
3. **Product characterization** – support in the definition of the product’s goals, requirements, and limitations;
4. **Information management** – includes all tasks dealing with management, storage or delivery of product or project-related information that can be used in the future;
5. **Support to decision making** – identifies the information required to decide and forecast the outcome of each option, and based on all items, determine which option is the best for that particular situation;
6. **Risk management** – identification, analysis, assessment, control, and avoidance, minimization, or elimination of unacceptable risks;
7. **Quality management** – management activities and functions involved in determination of quality policy and its implementation through means such as quality planning and quality assurance, including quality control.

Regarding the model’s completeness, it is difficult to make an evaluation because each model was designed for a specific purpose. As an example, let us focus on the representation of Pietzsch et al. (Pietzsch et al. 2009) (Figure 3.11). This model is based on a best-practice analysis and in-depth interviews with experts actively involved throughout the development, commercialization, and regulation of medical devices in the USA. Thus, it only reflects the reality of the USA’s market. Kramer (Kramer 2010) criticizes this model for the absence of ‘design’ in the development of medical devices.

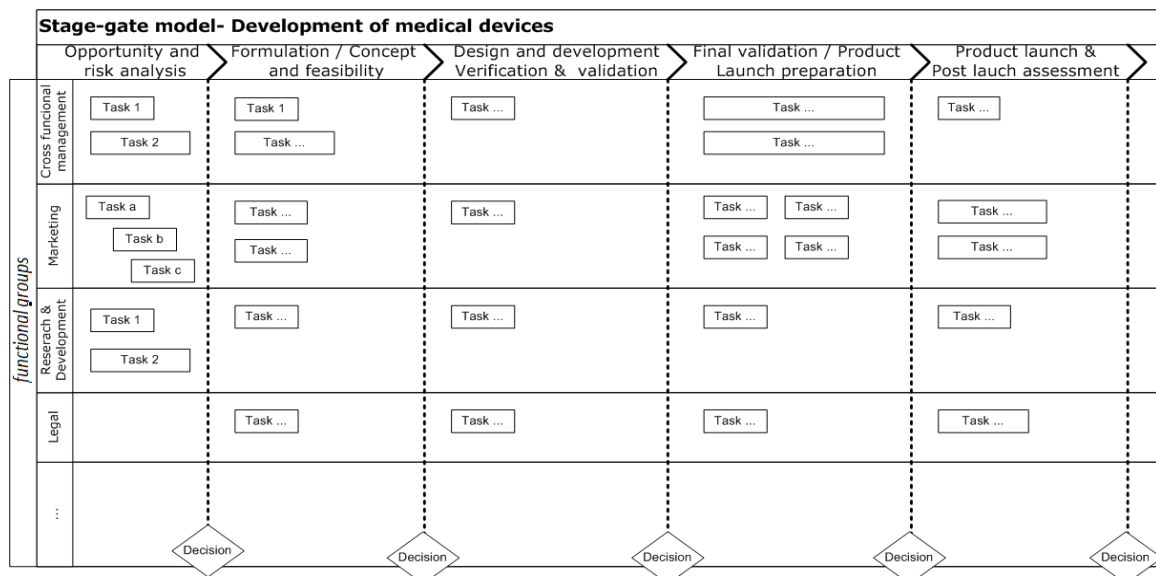

Figure 3.11: Representation of the medical device development process presented by Pietzsch et al. (Pietzsch et al. 2009).

The selection of an adequate model depends on its intended function. Each designer or company should understand its development process, define measures of success, and then identify what can be improved; a good indicator of the need for improvement is the amount of redesign. The adopted model should contemplate the company's culture as well as the product being developed (Unger and Eppinger 2011).

3.5 Chapter takeaways

Process modeling refers to the activity of representing processes. In this chapter, the models concerning new-product development, specifically of medical devices, were reviewed. 32 publications were analyzed, and it was found that most of them focus on just one topic and none addresses themes such as health technology assessment or human factors engineering. In addition, few studies address how information should be displayed. Overall, it can be said that, so far, there is no comprehensive model in the literature.

It is commonly accepted that by adopting a new-product development process, products get to the market faster giving companies a competitive advantage and better financial return. In addition, process modeling has proven to be an effective and efficient way to improve the process's performances. Thus, the modeling of the development process of medical devices is expected to provide companies and designers with a valuable tool to support their growth. However, this should not be seen as a panacea because, even though it is possible to reduce the failure rate, there are no infallible methods for bringing products and services to the market, including medical devices.

As far as selecting a suitable development process and its representation, the decision belongs to the designer and its company. Still, some guidelines can be provided. The process should be prescriptive but, at the same time, leave some space for initiative and take account the learning from previews projects because procedures that are too rigid can work against the development team. Finally, the process should work as a guideline and allow for variations to be implemented in determined circumstances.

4 New methodology for the development of medical devices

4.1 Introduction

Although the specifications for a wooden tongue depressor are quite different from the ones of a transcatheter aortic valve, they are both medical devices and, consequently, have to comply with similar requirements regarding quality, safety, and effectiveness. The study on the development process of these devices is relatively new and there are some publications on it. However, some gaps on its overall understanding still need to be addressed, since the current procedures either focus on a subgroup of medical devices or neglect to take under consideration some of the devices' peculiarities, such as multiple users, multidisciplinary development teams, or health technology assessment (HTA) being one of the adoption factors of healthcare technologies.

Pitta et al. (Pitta and Pitta 2012) studied the need to increase the success of the new-product development (NPD) process and, in spite of the paucity of historical data on NPD failure rates, they argue that a symptom of the need for change is the persistent level of new product failure. As far as the development of medical devices is concerned, data on failure rates is also scarce, but one can assume that the current development methods can be improved because commercial flops still occur as well as medical device recalls. In this chapter, examples of commercial flops and recalls are presented, and then it is proposed a dedicated methodology for the development of medical devices.

This chapter contains work and results presented in article 'Concept selection in the development of medical devices: the case of the smart stent-graft' by Isa C.T. Santos, Luís Rocha, and João Manuel R. S. Tavares published in the June 2011 issue of the journal *Journal of Medical Devices*.

4.2 Commercial flops and recalls

A commercial flop refers to a commercial failure, that is, a product that does not accomplish the desired aim or meets the expectations of success driven either by substantial financial investments or extensive publicity. The concept and the degree of failure are ambiguous and severely influenced by personal feelings, tastes, or opinions; it can be said that the identification of criteria for failure or success is an Homeric task. Nonetheless, a failure should never be considered a total failure as long as it teaches something.

Table 4.1 enumerates causes for the commercial failure of medical devices. Following, three examples of failures that were mentioned in a discussion forum in the professional network LinkedIn between January and March 2012 are presented; these examples show distinct devices that failed for different reasons demonstrating that the concept of failure is somewhat subjective.

Example 1:

In 1996, Boston Scientific (Natick, MA, USA) acquired MinTec Inc. (Freeport, Bahamas), a small

Table 4.1: Causes for commercial failure of medical devices.

commercial failure
→ do not meet a need
→ insufficient testing
→ poor design
→ poor performance
→ poor material selection
→ ethics
→ lack of evidence
→ obsolescence by next generation, alternative treatments, or modification of legislation
→ does not meet regulatory requirements
→ misunderstanding of the acquisition process
→ improper reimbursement code
→ high price
→ inadequate reimbursement level
→ inadequate marketing strategy
→ inexperienced management
→ others

company pioneer in the development of endovascular stent-grafts. This strategic decision allowed Boston Scientific to combine their graft technology with MinTec’s proprietary stent technology platform and launch the Vanguard stent-graft for endovascular aneurysm repair (EVAR) of abdominal aortic aneurysms (AAA or triple A’s). The Vanguard device (Figure 4.1) evolved from the Stentor (MinTec, Freeport, Bahamas), and was a modular stent-graft consisting of a nitinol frame covered with a polyester graft (Kaufman et al. 1999). It became available for clinical use in 1996 but only reached the European market in July 1998. The clinical trials in the USA began in 1997, but they showed that the device led to several complications, namely component disconnection and fabric erosion (Chuter 2002). Based on these results, the US study was terminated and the device was withdrawn in Europe.

The Vanguard stent-graft is an example of a medical device that failed to perform its intended function and, consequently, failed to meet the regulatory requirements. The device’s poor performance can be explained by the novelty of the technology (EVAR had been introduced in 1991), and the lack of a satisfactory *in vivo* animal model of the disease or an *in vitro* model that provided a meaningful simulation of it (Beebe et al. 2001). The design of current stent-grafts is similar to the one of the Vanguard device and lead to the same type of complications; however, the incidence rate is much lower.

Example 2:

Commonly, water jet cutters are associated with industry and the sectioning of materials such as steel, granite, and wood. However, the German ERBE Elektromedizin GmbH developed one for surgical tissue separation. With the ERBEJET® 2 (Figure 4.2), by varying the pressure of the water jet between 20 and 40 bar, it is possible to selectively dissect different tissues (Rau et al. 2008). Although the manufacturer advertises advantages such as tissue selectivity, reduced blood loss,

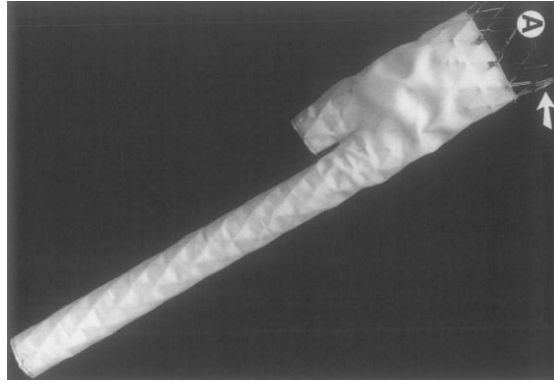

Figure 4.1: The Vanguard stent-graft (from (Kaufman et al. 1999)).



Figure 4.2: On the left, the ERBEJET® 2 from ERBE Elektromedizin GmbH; on the right, selective tissue dissection (from(Rau et al. 2008)).

shorter operation times, and lower costs, the device did not become popular (Poon 2007). A surgeon from the University of Birmingham (UK), in an informal conversation, explained why the device failed: the device had a long learning curve and, using this technology, visibility is affected hindering the surgeon's work.

Example 3:

In the early 1980s, the high failure rate associated with total knee fixed hinged prostheses drove the development of rotating hinged ones. Among the implants available was the Rotaflex, a prosthesis that allowed some rotation with flexion (Figure 4.3). In spite of those involved in the development of this device consider that sales were good, it is an example of a market failure because it led to complication rates near 80% (Fuchs et al. 2004). Out of curiosity, this device was initially named 'Rotoflex', but when it was pointed out that 'roto' in Spanish meant 'broken', the name was changed to 'Rotaflex'; considering that the device was redesigned several times in the late 1980s and 1990s, the original name showed foreknowledge!

The list of market failures of medical devices could continue with the Ivac syringe pump 740 series that was considered technically very good but ugly, the Charnley hip replacements with Teflon cups that had poor wear properties, and others. However, this type of information is difficult to find because most companies are unwilling to announce that they were responsible for a market failure. On the other hand, information about medical device recalls is widely available either in the news, the manufacturer's webpage, or in dedicated webpages such as the one from FDA (FDA 2012c) or 'MedicalDeviceRecall.com'. In the USA, this information is also available in the webpages of lawyers.

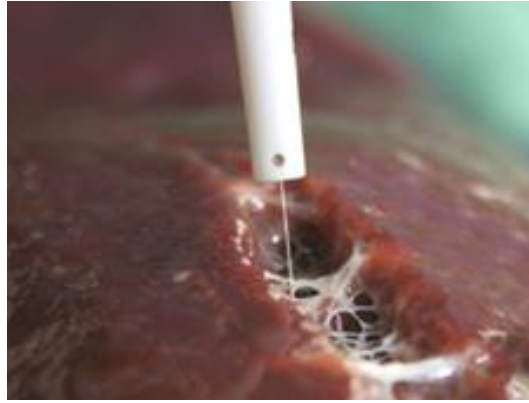

Figure 4.3: Rotating hinge knee prosthesis (adapted from (Guenoun et al. 2009)).

From a product development point of view, a medical device recall represents a failure in the delivery of a reliable and high quality product. For instance, in October 2011, Health Canada (the department of the Canadian government with responsibility for national public health) alerted for a problem in the Steri-Drape Roll Prep Drape from 3M Health Care: the drape did not unwind from the roll, making the product unusable. In June 2011, a manufacturing irregularity in some batches of the HandyVac from Unomedical (Worcestershire, UK) caused leakage and justified the release of a Field Safety Notice (FSN) (NHS Supply Chain 2011). Another example dates back to November 2010 when FDA announced the recall of Medtronic's Dual Chamber Temporary Pacemaker because the device was unable to power up or could power down unexpectedly (FDA 2010).

An interesting research would involve the categorization of all the reported recalls based on different causes (i.e. design error, packing error, mislabeling, and others) to understand their source, their impact, and how they can be mitigated.

4.3 Evolution of the proposed methodology for the development of medical devices

Although there are some publications addressing the development process of medical devices, the information is generally scattered and is laborious to find by those unfamiliar with the process. Hence, two main purposes of the proposed methodology are to gather the relevant information to the development of medical devices, and present it in an easy-to-use format.

The development process of medical devices was represented graphically because that is the most practical, easiest, and fastest way to maintain, understand, and communicate information (Lugt 2000). Furthermore, it facilitates the identification of the elements driving the process and reduces the complexity of the reality being represented.

The methodology proposed is both prescriptive and generic; that is, it depicts the steps that one should follow in order to successfully develop a medical device regardless of its complexity. However, it should not be seen as a universal solution, but as a starting point and should be custom-tailored to the specificities of the device as well as the company's philosophy, needs, and goals.

The development of the new methodology (Figure 4.4) started with a literature review and document analysis to identify the peculiarities of medical devices as well as to find a consensual product development process. Then, the process was represented as a flowchart and the peculiarities found were associated to the tasks as ‘kaizen lightning bursts’ * given an idea about which tasks should be reviewed or might be missing.

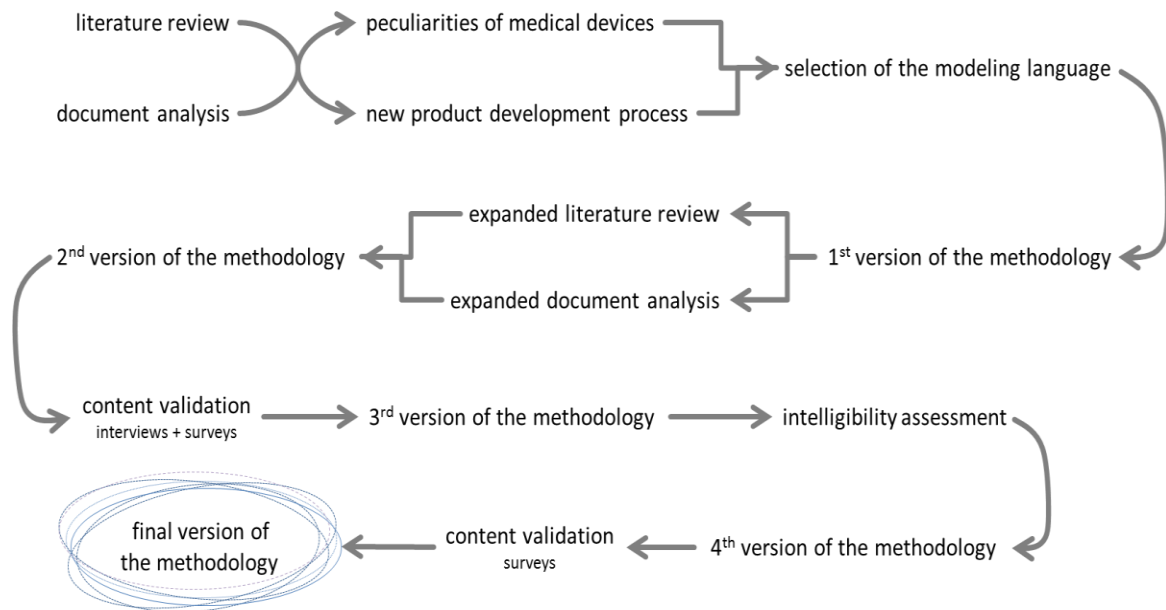

Figure 4.4: Evolution of the proposed methodology for the development of medical devices.









The following step was the selection of a modeling language. Business Process Model and Notation (BPMN), whose symbols are explained in Table 4.2, was chosen because it expresses a process flow, it is independent of the implementation environment and, as it is based on flowcharting, it is easily understood (Natschläger 2011). Although tasks were represented sequentially, they can occur concurrently. Furthermore, no functional group, e.g. marketing or engineering, was attributed, but they can be easily included using the modeling language’s concepts of ‘pool’ and ‘lanes’.

The first version of the methodology was complemented with information gathered during an extended literature review and document analysis.

In order to determine the pertinence of the tasks included in the second version of the methodology and identify missing concepts, the methodology was presented to members of academia, industry, and regulatory bodies in an online questionnaire adapted from the work of Medina et al. (Medina et al. 2011) and during structured interviews. The respondents (Figure 4.5) answered open and closed questions about the significance of the tasks presented, if they agreed with the graphical representation, and if any concepts were missing. Overall, the concepts included were considered either important or critical, but topics such as manufacturing, quality, and post-market surveillance were deemed to be incomplete.

* Kaizen refers to philosophy or practices that focus upon continuous improvement of processes in manufacturing, engineering, and business management. During its implementation, the current state is represented and the opportunities for improvement are signaled visually by a ‘kaizen lightning burst’.

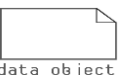
Table 4.2: Basic BPMN modeling elements (adapted from (Briol 2008)).

Notation	Element	Description
	Start event	A particular Process starts
	Intermediate event	An event that occurs between a Start Event and an End Event. It affects the Process' flow but does not start or terminates it.
	End event	A particular Process ends
	Gateway	Exclusive decision
	Task	Work performed during the Process
	Collapsed task	Sub-process not visible in the diagram
	Data object	Provides information about what Tasks require to be performed and/or what they produce
	Text annotation	Provides additional text information for the reader

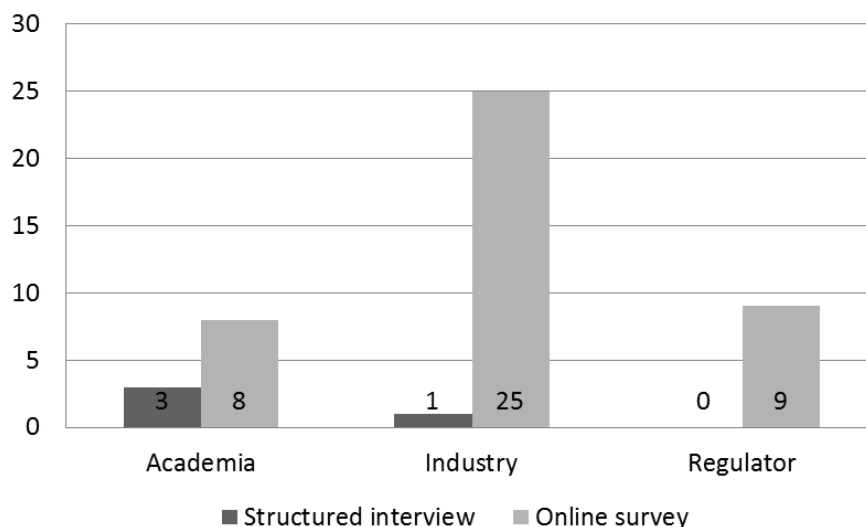

Figure 4.5: Number of respondents to the first content validation.

The methodology was reviewed once again, and the result was presented to Industrial Design students to assess its intelligibility. Considering the students' comments, a fresh version of the methodology was prepared and submitted to a new scrutiny: an online questionnaire that was made available in the professional network LinkedIn.

The second questionnaire included questions similar to the ones in the first questionnaire. In spite of the few valid answers, only 16, all the tasks included were considered either important or critical, and no concepts were deemed to be missing. However, were made some suggestions reflecting the respondents' personal experience to rename some tasks and modify the graphical representation to make clearer the iterative nature of the process. After minor adjustments, the final version of the methodology, which is described next, was reached.

4.4 New methodology for the development of medical devices

The development process of medical devices was divided into five stages: ideation, concept development, design, regulatory approval and clearance, and post-market activities (Figure 4.6). Typically, new-product development representations disregard market entrance and post-market activities. However, in the case of medical devices, these steps are important and should be represented because they can have repercussions on the pre-market activities. For example, during the approval process, it may be required to change the device's design in order to meet the regulatory requirements, or with the information gathered during the post-market activities a new need may be identified or a new concept generated.

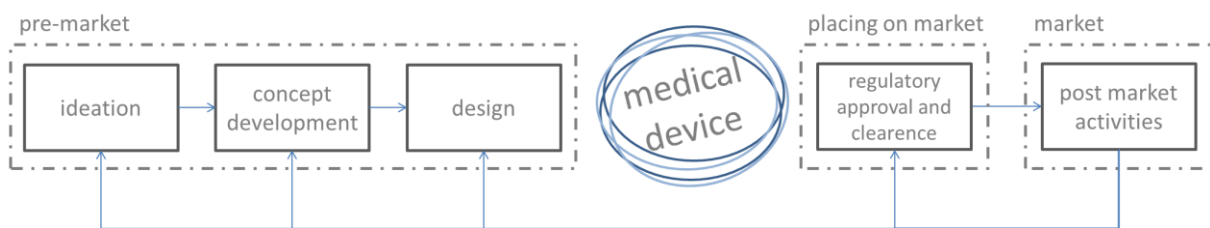

Figure 4.6: The development process of medical devices.

During the development of new products, the curve cost vs. development time is plotted to serve as a mental model and support decision making (Smaling and Weck 2007). Although commonly no quantitative data is presented, the curve has an S-shape with an inflexion point close to concept selection. As far as medical devices are concerned, the cost– development time curve, instead of one inflexion point, is likely have two (

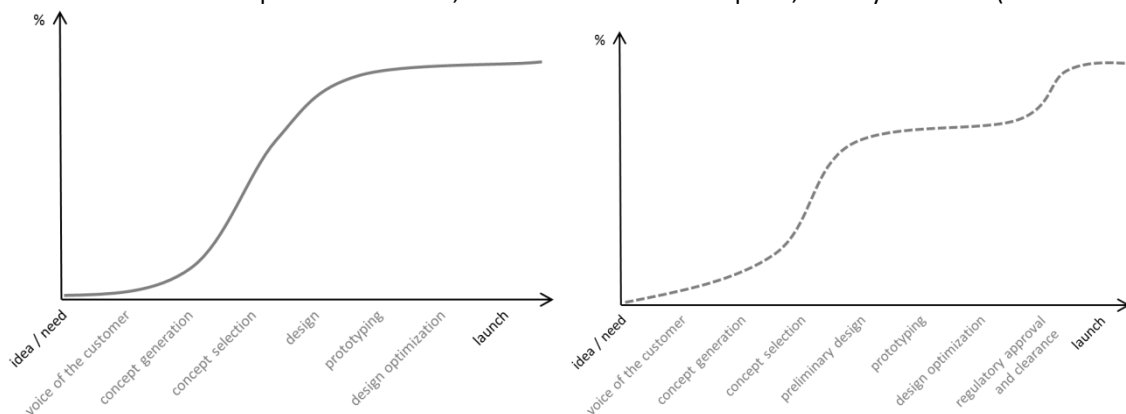

Figure 4.7): one next to concept selection, and the other before the device's market entrance. The second point will be driven by costs associated with device's market entrance, e.g. fees, clinical trials, and other expenses. Hence, the slope of the curve will be related with the device's risk class: the higher the risk class, the steepest the slope. However, this hypothesis needs to be confirmed with data from industry.

4.4.1 Ideation

The word 'ideation' is defined as the formation of ideas or concepts but, in this text, has a broader meaning and should be understood as a plan, thought, or suggestion about what to do. So, equally suitable names for this stage would be 'idea creation', 'opportunity detection', 'opportunity selection', or 'planning'.

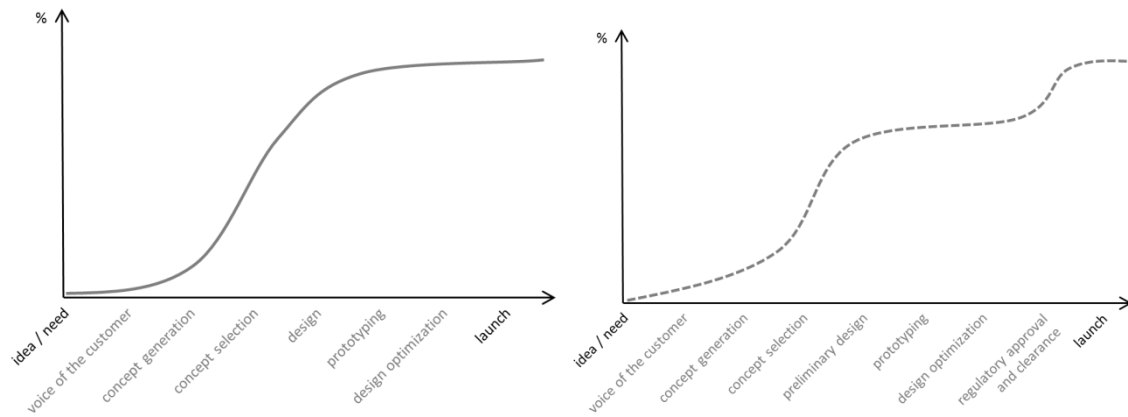

Figure 4.7: On the left, the typical curve cost– development time; on the right, the proposed curve for the development of medical devices

Typically, the DPMD begins with the identification of a need or an opportunity. Needs are either obvious or unrecognizable by those close to them, and may appear from different sources such as client requests, the analysis of data obtained during post-market activities, and market analysis. Opportunities also have various sources, namely the possibility to apply new technologies or knowledge, e.g. decoding the human genome allowed the appearance of gene therapy. In either case, the formulation of needs and opportunities is important and may influence the project’s success.

In spite of not existing a formula to express needs and opportunities effectively, there is a recurrent mistake in product development that should be avoided: embed the solution in the need. For instance, saying that ‘there is a need for socks that are white in the inside and colorful in the outside to facilitate the detection of injuries in the feet of diabetics because they dislike wearing white socks’ would define the scope of the need too narrowly. A better formulation would be ‘a solution to facilitate the detection of lesions in the feet of diabetics’. With the latter, not only new socks’ tissues and designs would be considered but also the use of sprays to detect fluids resulting from the lesions and others.

The existence of a need or an opportunity is not synonym of a market opportunity; that is, from a commercial point of view, the need or opportunity may not be rewarding. Hence, a market analysis should be performed and information gathered on the market size, market growth rate, market profitability, market trends, and market segmentation as well as the willingness to pay, and the target market. Notice that, at this point there is little information and the purpose of this analysis is to understand the relevance of the topic addressed.

If the need or opportunity does not represent a potential market opportunity, it should be filed but revisited regularly. For example, ultrasound testing was invented in 1826, but only began being used in medical diagnosis in the 1940s; this means that the new technology took more than a century to become a market opportunity in the medical device sector.

On the other hand, when facing a market opportunity, one should select the markets where the device will be commercialized because that determines the regulatory framework and the regulations that the device will have to comply with. Following, the development process should be planned, specifically the project’s duration, resources, and risk. In spite of the process still being in an

early stage, topics such as the regulatory strategy to enter the market, coding, reimbursement, and marketing should be addressed so that the development team can be prepared for the hurdles ahead and avoid surprises.

With the development process of the novel medical device defined, a business analysis (Table 4.3) should be performed and the results compared with the companies’ objectives, strategies and procedures. If the need or opportunity does not meet the company’s objectives, it should be filed and revisited regularly. On the other hand, if the company is willing the proceed with the development process, it should prepare a mission statement containing a description of the problem being addressed with the corresponding market opportunity, the key business goals, the primary and secondary markets, the assumptions and constraints, and the stakeholders.

Table 4.3: Business analysis techniques (adapted from (Cadle et al. 2010)).

Technique	Acronyms	Application
MOST	Mission Objectives Strategy Tactics	Helps gaining an understanding of what the organization wishes to achieve (its mission and objectives), and how it is going to do it (its strategy and tactics)
Boston Box		Aids portfolio management
SWOT	Strengths Weaknesses Opportunities Threats	Summarizes and consolidates the key issues identified when analyzing an organization and its business environment

Figure 4.8 summarizes the ideation stage graphically.

4.4.2 Concept development

Figure 4.9 summarizes graphically the concept development stage. More often than not, the borders between the beginning of this stage and ideation are blurred because as the knowledge of the problem being addressed increases, the need, opportunity, or market opportunity evolves.

In the development of any product, it is important to maintain records to register decisions and capture both explicit and tacit knowledge. It is commonly accepted that documentation facilitates reuse, avoids repetition of errors, and keeps knowledge in-house when contracts expire, companies reorganize themselves, and employees move on to new jobs. In the case of medical devices, this is no different. In fact, information on the development process of a novel medical device is requested during the approval process for market entrance, e.g. FDA’s quality system regulation requires a design history file (DHF), and, in Europe, either a technical file for class I, class IIa, and class IIb medical devices, or a design dossier for class III devices has to be submitted.

The format and content of a technical file varies by assessment entity. However, it should be organized, concise, and coherent to facilitate review, and include the following information:

- description of the medical device and its accessories, namely the design, design changes, materials, components, characteristics, performances, variations in the family, packaging, and literature;

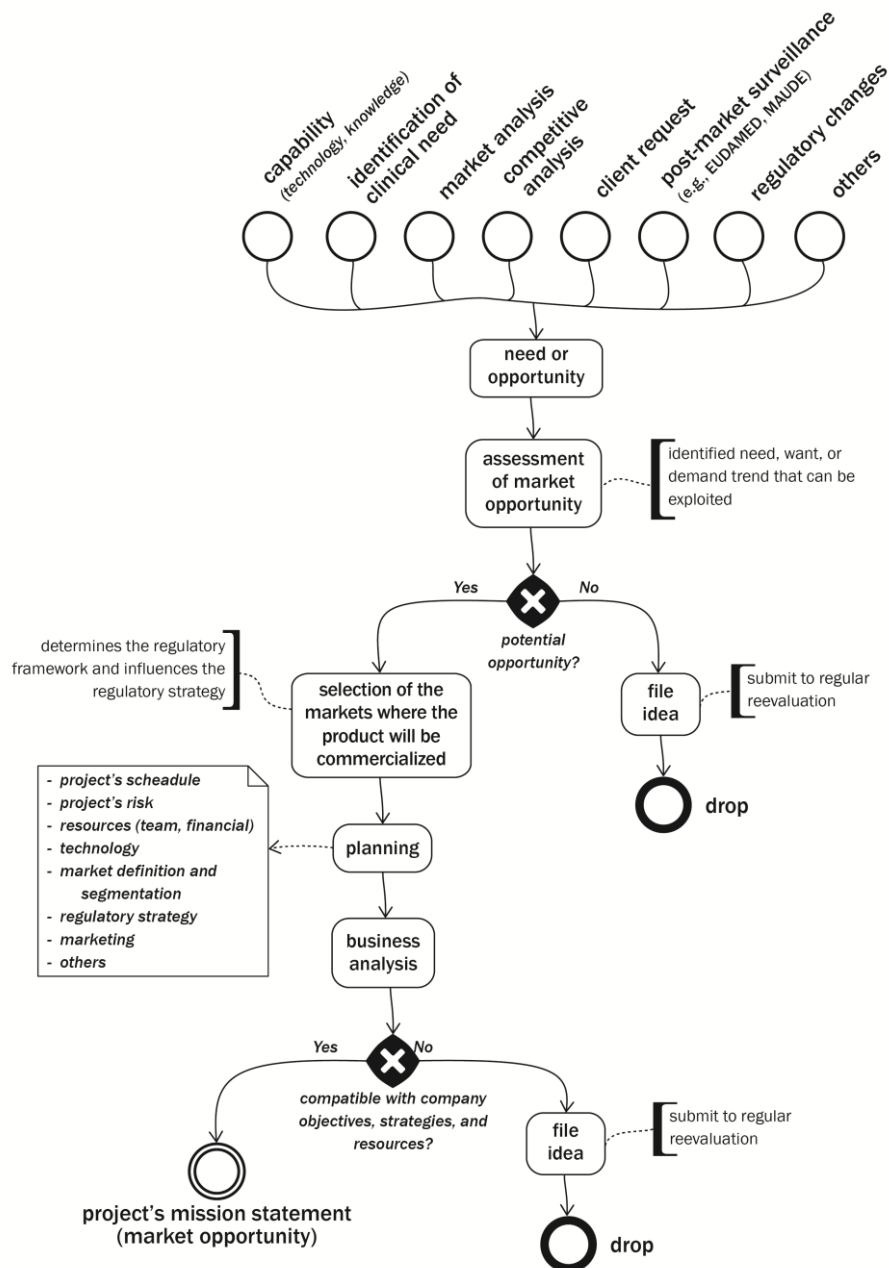

Figure 4.8: The ideation stage.

- drawings and images;
- the device's intended use, patient population, and medical condition;
- the device's shelf life and environmental limitations;
- procedures for installation, preparation for use, pre-use checks and maintenance, calibration and servicing;
- testing protocols and results, including but not limited to, in-vitro performance or safety, mechanical, physical, chemical and/or animal studies, biocompatibility, packaging, shelf life, stability, and sterilization;
- clinical evaluations;
- description of the design and manufacturing process, including the identification of the suppliers and subcontractors;
- description of the quality system;

- risk assessment;
- the rationale for the device’s classification and conformity assessment route; and
- post-market procedures.

As in the development of medical devices are often involved multidisciplinary teams, the technical file can also include a glossary as well as the information gathered during the study on the medical condition (Table 4.4).

The study of the medical condition prepares the design team for the forthcoming tasks; not only it explains the problem to be addressed and teaches the terms typically used, but also pinpoints who are the customers and where to find competitor products. Here the expression ‘competitor products’ has a broad scope, and it encompasses both similar and substitute commercial products as well as alternative treatments and procedures, technologies under development, and patents.

Table 4.4: Topics that should be addressed in the study on the medical condition (adapted from (Zenios et al. 2010)).

Anatomy and physiology	Description of the normal anatomy and function of the cells, tissues, organs, and body parts affected by the medical condition
Pathophysiology	Description of the changes of normal mechanical, physiological, and biochemical functions, either caused by a disease, or resulting from an abnormal syndrome
Clinical presentation	Description of the physical signs (what to find in on a clinical exam or lab testing) or symptoms (what the patient feels and suffers from) associated with the disease process; their interpretation often leads to a specific diagnosis
Clinical outcomes	Description of the outcomes of the medical condition
Epidemiology	Description of the causes, incidence, distribution, and control of the medical condition
Treatments	Description of the existing and emerging therapies, including behavioral and lifestyle modifications, pharmacologic or biologic therapies, energy-based therapies, open surgery, and percutaneous and minimally invasive treatments Identification of who diagnoses the medical condition, who provides the multiple levels of treatment, who manages the medical condition, how payments are made and by whom

Together with the study of the state of the art, it is necessary to understand what customers’ desire, i.e. identify the customers’ expectations, preferences, and aversions. This task, commonly named as voice of the customer, is itself a process and includes the following steps: identify customer, develop or select survey methods and tools, gather raw data from customer, identify and rank needs (Figure 4.10).

A correct categorization of the customers can dictate the success or failure of a device. To identify customers and determine their interaction with the device several questions can be posed. For instance, to determine the payer and the willingness to pay one should ask:

- Who is the purchaser? Is it the patient or a health insurance / government?
- Is the purchaser the user?

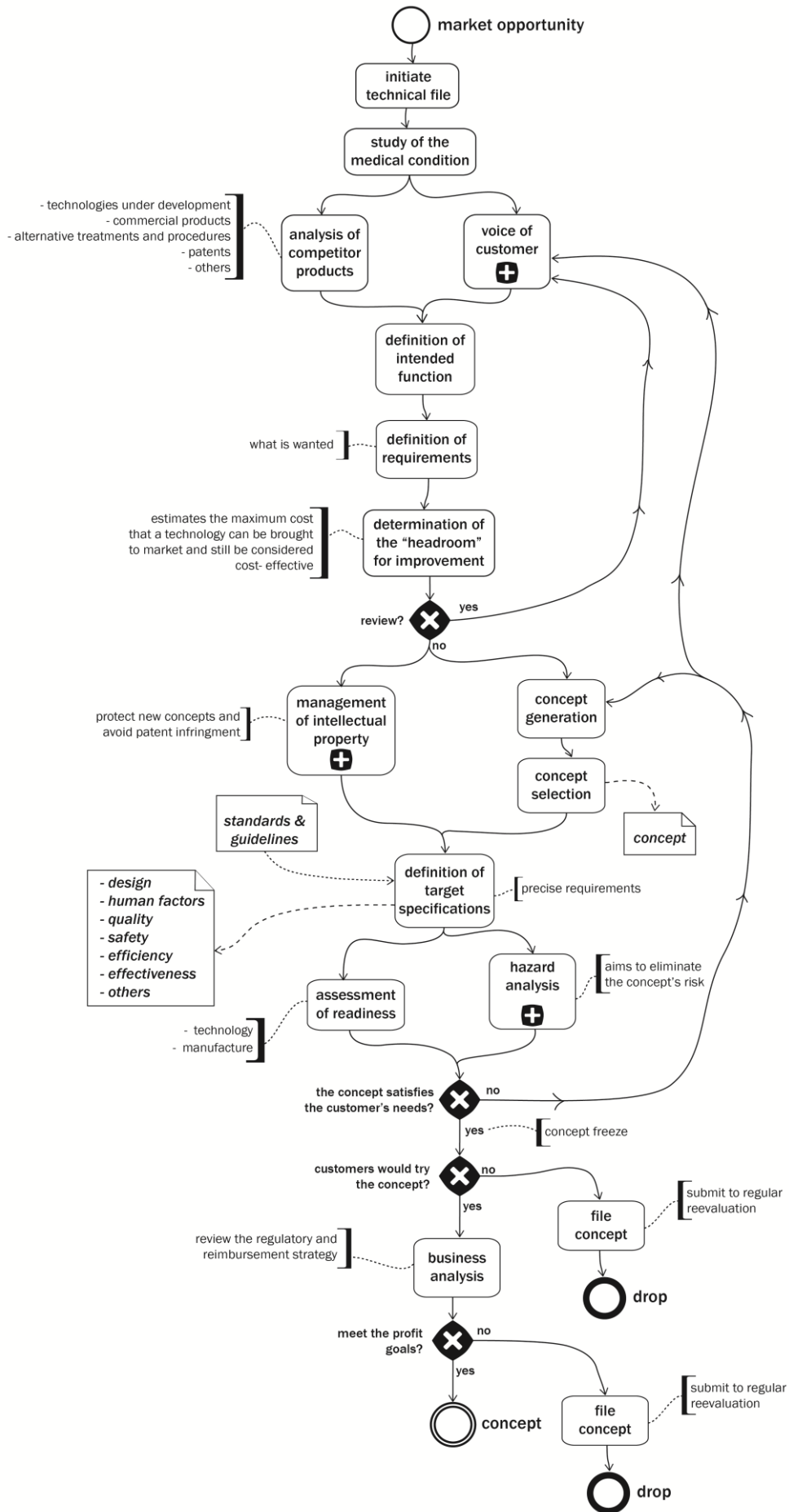

Figure 4.9: The concept development stage.

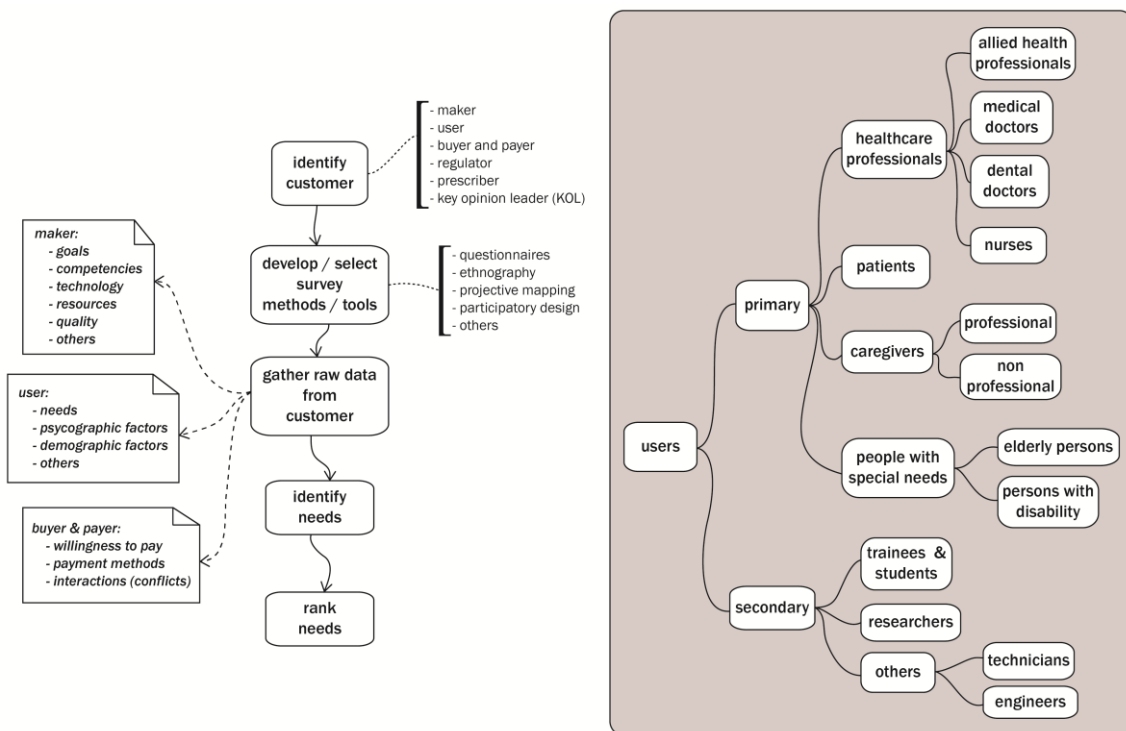

Figure 4.10: The voice of the customer sub process.

- Who influences the purchase?
- The purchase is fully reimbursed or co-paid?

To determine the device's characteristics and how the device will be adopted the following questions should be answered:

- Who will be the hands-on user of the device?
- Are the users likely to be specialists?
- What is the level of training, education, and experience of the users?
- Who are the patients or individuals upon whom the product is being used?
- What is the environment in which the product is being used?

Once customers are identified the following steps are the development and/or selection of the survey tools and their application. The purpose is to understand how users interact both physically and mentally with the devices, and list the limitations of the environment (space, light, temperature, and others). Table 4.5 presents, in alphabetical order, some of the tools that can be used in this early stage of the development of a novel medical device. However, their selection and application depends on the time, resources, and participants available.

In any stage of the development process of a healthcare technology, the recruitment of participants is difficult. In addition to the natural limitations of the participants, e.g. technical knowledge and time, when studies are intended to be carried out in healthcare facilities, it is necessary to obtain ethical and research permission from the relevant authorities. This procedure varies by entity and can be long delaying the collection of the data. Alternatives to reduce costs and speed data collection are the contact with patient groups and professional bodies, the study of medical device recalls, complaints, and guaranties as well as the analysis of blogs and forums in the internet.

Table 4.5: Tools for capturing the voice of the customer (adapted from (Martin et al. 2006; National Patient Safety Agency 2010)).

Tool	Description	Further reading
Contextual inquiry	It is also known as shortened ethnography and consists of short, targeted observations and interviews that may be influenced by pre-determined research questions, e.g. 'What are you doing?', 'Why are you doing it like that?', 'Would it be better if you could do it like this?'	(Beyer and Holtzblatt 1997)
Delphi technique	Consists of rounds of questions to progressively identify, clarify and expand on issues and ideas. Typically, the first round includes general questions to gain a broad understanding; the following rounds are based on the results of the previous round to investigate further or clarify the issues raised	(Okoli and Pawlowski 2004)
Ethnography	The researcher spends an extended period (often months or even years) studying users within their work and/or home environment, observing their behavior and interactions with the devices	(Goodson and Vassar 2011)
Focus groups	Consists in a small group, typically with 8 people, discussing a particular issue or product	(Langford and McDonagh 2002)
Interviews	Consists in a conversation where the interviewer asks questions to obtain information from the interviewee	
Questionnaires	Consists in a set of survey questions designed to extract specific information	(Boynton and Greenhalgh 2004)
Task analysis	Examines a particular task and to break it down into the actions, decisions and/or cognitive processes that are necessary to complete it	(Gupta 2007)

Regardless of the source, the information gathered has to be translated into needs. To aid in that task, Ulrich and Eppinger (Ulrich and Eppinger 2011) proposed the following guidelines:

- Express the need in terms of what the device has to do, not how it might do it;
- Express the need using the same level of detail that was used in the raw data;
- Express the need as an attribute;
- Avoid the words 'must' and 'should'.

Ranking needs can be a Homeric task but is essential to prioritize resources as well as plan the device's future versions. One possibility to accomplish such ranking is to attribute different weights to the needs but that is a subjective procedure. In this scenario, the Kano model is impartial because needs are grouped into 'must-bes', 'satisfiers', and 'delighters' considering the customers answers to a specific questionnaire (Matzler and Hinterhuber 1998; Sharif Ullah and Tamaki 2011).

Finally, it is possible to define the device's intended function and its requirements; that is, what the device is expected to do.

Considering the increasing influence of HTA, determining at this early stage the maximum cost that the device can be brought to market and still be considered cost-effective can represent a competitive advantage. This value can be determined using the headroom method (Cosh et al. 2007; McAteer et al. 2007). This method involves establishing the 'headroom' in effectiveness, i.e. the room for improvement in effectiveness between the current best treatment and that which the new technology might plausibly achieve, and estimate optimistically the maximum additional cost that the new device could still be considered cost effective.

With the information gathered thus far, the design team can generate concepts for the novel device. There are many methods for concept generation, Table 4.6 shows just a few. Ideally, the design team should be familiar with several tools and use them, or a combination of them, as needed.

Table 4.6: Tools for concept generation (adapted from (Miller 2012; Silverstein et al. 2008)).

Tool	Description
Brainstorming	In a relaxed environment, a relatively small group of people presents ideas as they appear and discusses them in a positive manner
Brainwriting	A group of persons are asked to each individually come up with a number of ideas and write them on a sheet. The sheets are then exchanged, and individuals add to the list with improvements or ideas sparked from the ideas already on the sheet. This is then repeated a number of times until a sufficient number of ideas is generated
SCAMPER	It is an acronym for: Substitute, Combine, Adapt, Modify, Put to Other Use, Eliminate, and Reverse or Reorder. An initial idea is explored considering the verbs in the acronym
Morphological method	It is a two-step approach. In the first step, the multiple functions of the device are identified and concepts for each function are presented. In the second step, the multiple concepts are combined to meet all the functional requirements

During concept generation, the management of intellectual property (Figure 4.11) plays an important role: besides protecting new ideas, avoids infringements. In fact, considering that according to the World Intellectual Property Office (WIPO) there are 40 million patents, it can be a source of both concepts and new technologies to be used in the novel device.

If the concept generated meets the patentability requirements, the design team can protect it through trade secrets or patents. Patents are granted by patent offices and give their owners a territorial and limited in time right to prevent others for making, offering, storing, commercializing, using, importing or possessing the invention without consent. On the other hand, if the concept is already protected, the design team has two options: design around, i.e. find alternatives to avoid infringing the patent's claims, and licensing. The latter refers to a legal contract that defines the exploitation rights granted.

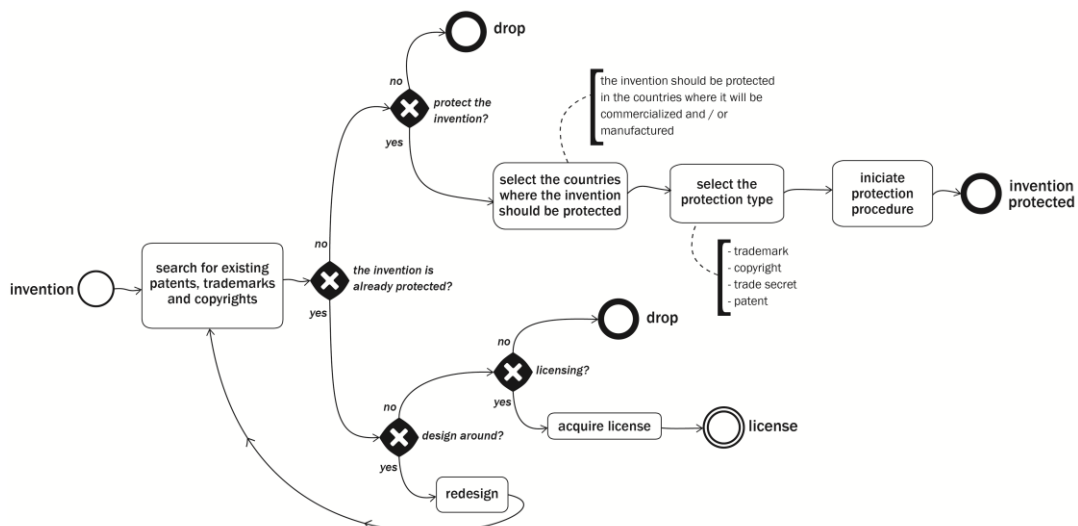

Figure 4.11: The management of the intellectual property sub process.

Even if every concept generated is protected by a patent or a design, only one or two will be further developed. There are several tools available to select concepts (Okudan and Tauhid 2008), namely external decision, product champion, decision matrixes, and others. Considering the increasing importance of HTA, next, it is suggested a new tool that estimates the concepts' expected value (EV) and selects the option that provides the higher value. The aim of this tool resembling a decision tree is to select the most cost-efficient concept but still needs to be validated with real data.

The first step to apply this new tool is to organize the multiple concepts. Then, for each concept, the current treatment, and 'do nothing', the expected value is calculated applying the formula:

$$EV = p \cdot D \cdot \sum qm \cdot \prod ql \quad (1)$$

in which p represents the probability of a healthy outcome using the concept, D the demand, qm quantitative parameters that can be expressed in monetary units and ql qualitative parameters expressed as scaling factors. Although several metrics can be used, some are suggested and described next.

Probability refers to the probability of a healthy outcome using the concept, i.e. the probability of the concept not causing complications or requiring further treatments. Using historical data is possible to calculate this value. However, this task becomes more complicated in the case of devices yet-to-be-developed. Thus, a sensitive analysis is likely the best way to understand how the decision will be affected.

Demand is defined as the quantity requested by the consumers and is a function of the disease's incidence rate and the consumers' ability to pay. The demand of each concept can be obtained by analogy; that is, comparing each concept with the demand of devices with similar outputs.

The cost of the device refers to the price paid to acquire the concept, including its disposal. Depending on the type of the device, this value can be obtained either by analogy or by using a parametric model.

The cost of the procedure is the price paid for the patient to receive the concept; it includes every cost from the patient's arrival to his release from the hospital. This parameter can be determined using a bottom-up approach (engineering buildup), which is a method that sums up all the relevant parts.

The cost of use and maintenance refers to the value spent to benefit from the concept, namely medication and energy. It also includes the value spent to restore the concept to a specified condition. Like the cost of the procedure, the cost of use and maintenance can be determined using a bottom-up approach.

Follow-up costs refer to the value spent to assure the proper functioning of the concept and can be determined using a bottom-up approach.

Losses to the patient reflect the value lost by the patient due to its condition; it includes the expenses that the patient and his caregiver incur due to the disease, and the expenses with transportation to and from the appointment. This parameter can be determined using a bottom-up approach.

Willingness to pay (WTP) means the maximum amount of medical cost a patient is willing to pay to gain benefit or prevent any risk in medical care. It may vary, depending on age, income, level of education, severity of disease, possibility of cure as well as healthcare service and culture. WTP is expressed in monetary units. Regarding its calculation, the literature has different methods to measure the consumers' hypothetical or actual willingness to pay and whether they measure consumer willingness to pay directly or indirectly.

Effectiveness is a qualitative parameter that measures the degree to which the concept is successful in producing the desired result, and reflects whether the concept is sufficient to treat the medical condition. This parameter is equal to the number of life years gained.

Security reflects if the concept has side effects or not, and can be measured in a scale, with the categories: non-applicable (nominal), safe (benefit), and unsafe (detriment).

Risk expresses the probability or threat of damage, injury, liability, loss, or other negative occurrence to both users and patients. It also considers whether the concept represents a risk during its manufacture, transport, and disposal. Like medication security, this parameter is measured in a scale with the categories: neutral (nominal), very low (benefit), low, medium, high and very high (detriment).

There is an extensive literature about quality of life. In this case, quality of life is defined as the ability to enjoy normal life activities.

Recyclability is a qualitative parameter that expresses the ability of the concept to be captured and separated for conversion or reuse. It can be recyclable (benefit), non-recyclable (detriment) or non-applicable (neutral).

The technology maturity reflects whether the concept's technology is known and used. This parameter is measured in a scale, with the categories being: development (detriment), introduction (neutral), growth (benefit), maturity (benefit) and decline (detriment).

Flexibility refers to the ability of the concept to have a different application other than the one it was initially developed for, i.e. to have an off-label use. It can be non-applicable, yes or no.

The scientific benefit reflects if the concept can contribute to a better understanding of the disease in which it is used or others diseases. It can either be yes (benefit) or no (neutral).

Selecting concepts estimating their expected value may help to reduce the chances of a commercial flop. However, this tool may be difficult to apply if the choice has to be made among many concepts or there is little data available.

Once a concept is selected it is crucial to clarify if it will be regulated as a medical device. For that, the medical device's definitions in the market where it will be commercialized should be checked. Only then, the target specifications should be defined, i.e. it should be specified how the customer needs will be satisfied. To complete this task, standards, guidelines, and regulations should be considered.

At this point of the development process, a hazard analysis should be performed to eliminate the concept's risks. As there is still little information about the novel solution, a task analysis may suffice.

This analysis along with the assessment of the technology and manufacture readiness (Figure 4.12 and Figure 4.13) can lead to new concepts.

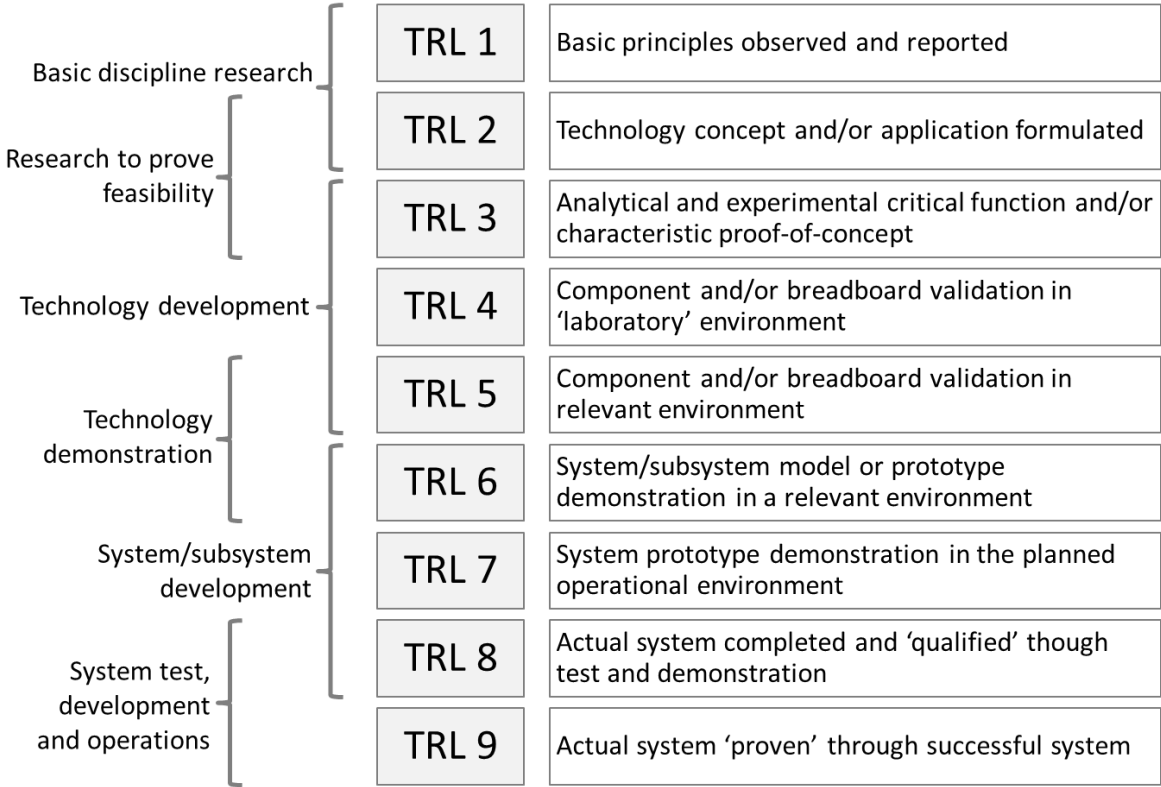

Figure 4.12: Overview of the technology readiness level (TRL) scale. TRL is a measure to assess the maturity of evolving technologies (materials, components, devices, etc.) prior to incorporating that technology into a system or subsystem (adapted from (Mankins 2009)).

MRL 1	Basic manufacturing implications identified
MRL 2	Manufacturing concepts identified
MRL 3	Manufacturing proof of concept developed
MRL 4	Capability to produce the technology in a laboratory environment
MRL 5	Capability to produce prototype components in a production relevant environment
MRL 6	Capability to produce a prototype system or subsystem in a production relevant environment
MRL 7	Capability to produce systems, subsystems or components in a production representative environment
MRL 8	Pilot line capability demonstrated. Ready to begin low rate production
MRL 9	Low Rate Production demonstrated. Capability in place to begin Full Rate Production
MRL 10	Full Rate Production demonstrated and lean production practices in place

Figure 4.13: Overview of the manufacturing readiness level (MRL) scale (adapted from (DoD 2011)).

In the end of the concept development stage, a new business analysis, including the new information, specifically potential regulatory and reimbursement strategies, should be carried out. An assessment of what would happen if the project does not meet its deadlines can also be performed to identify the pros and cons of being the first in the market.

4.4.3 Design

Figure 4.14 illustrates the tasks typically performed during the design stage. During this stage, the concept is transformed into a product, and both the marketing and sales plans are defined. The intellectual property continues to play an important role not only to protect the manufacturing process but also to manage the product's brand identity (copyright, trademark, and design). Once the product and its manufacture are designed, the instructions for use and packaging are prepared. To ensure that the device meets the regulatory requirements, the quality system is implemented. With the new information, the device's cost is calculated, and a new business analysis is performed. If the profit goals are confirmed, production can begin.

Understanding the adoption factors of medical devices helps to define an efficient marketing strategy, specifically the four Ps: product, price, placement, and promotion. As far as the product is concerned, the marketing strategy should address what other products or services complement the device and how they can be offered. For example, when developing a glucometer it is necessary to design the lancet and the testing strips, define their packing and selling points. In the case of stent-grafts, it is common to offer technical support, i.e. a company employee being present during the surgeries. The reimbursement strategy is crucial to define the device's price, and the placement or distribution is determined by the coverage obtained, and the distribution channels selected. Finally, promotion not only includes advertisement but also the necessary training to ensure a correct use of the device.

Although product design (Figure 4.15) and manufacture design (Figure 4.16) were represented as two independent sub processes, their tasks are interrelated. In fact, there are advantages in blending the two because suppliers may participate in design of the device or the concept be modified to accommodate material or manufacturing limitations.

The tasks executed during product and manufacture design depend on the device. For instance, in the development of an ankle-foot orthosis, 'definition of systems and interface' and 'assembly and integration' may be unnecessary tasks, but they are crucial in the design of a pacemaker. Nonetheless, 'material selection', 'prototyping', 'design verification and validation', and 'design of the supply chain' deserve some remarks.

The infamous case involving the Poly Implant Prosthèse (PIP) breast implants, from the French company with the same name, illustrates the importance of material selection in medical devices. In a nutshell, the manufacturer filled the implants with a silicone gel with a composition different from that approved to (allegedly) cut costs and increase profits. Although the material was the same, the quality was different resulting in medical problems. Material selection in medical device design must consider not only engineering requirements but also biologic ones. Hence, to assist this task, dedicated databases should be considered.

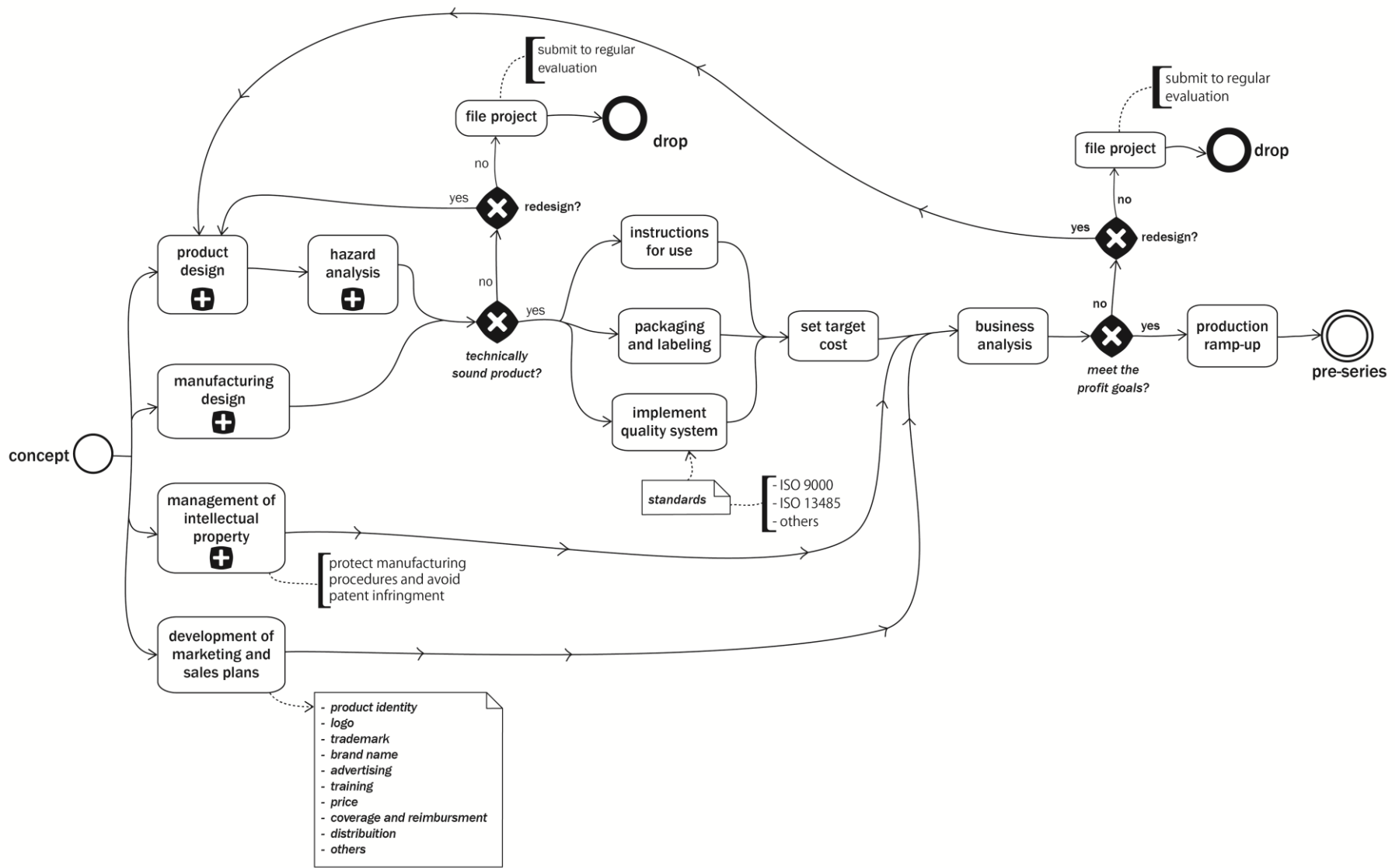

Figure 4.14: The design stage.

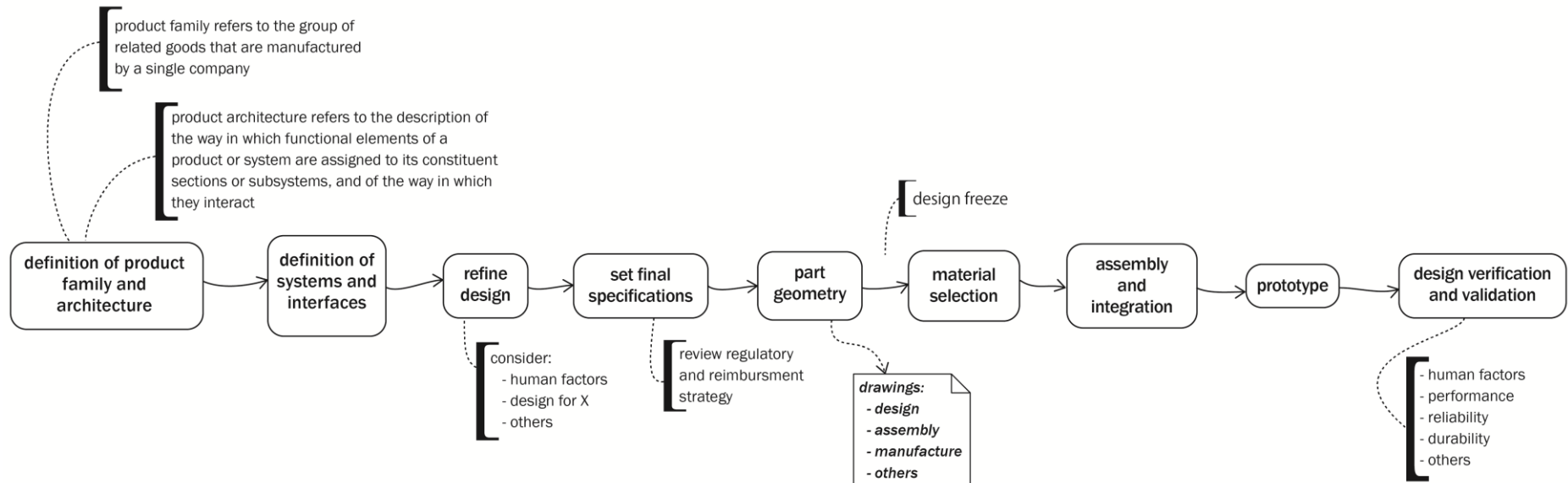

Figure 4.15: The product design sub process.

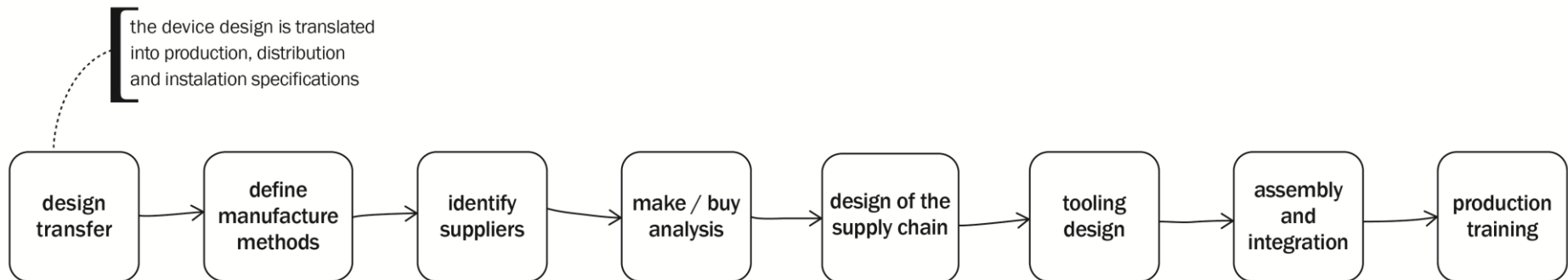

Figure 4.16: The manufacture design sub process.

Prototypes are typically used to test new designs. They can be used in different stages of the development process and, depending on what is being tested, they can range from simple visual models with limited or no function to full-functioning units.

Prototyping and design verification and validation often overlap. The later can be divided into three types of efforts: non-clinical, pre-clinical, and clinical (Figure 4.17). Non-clinical studies are performed during prototyping and typically address feasibility and usability issues. Pre-clinical studies aim to prove or disprove a specific hypothesis in small or large animal models as well as test the device’s safety and effectiveness. The results obtained at this point are helpful to obtain approval for first-in-man testing and establish the potential clinical value that motivates physicians to enroll patients in further studies.

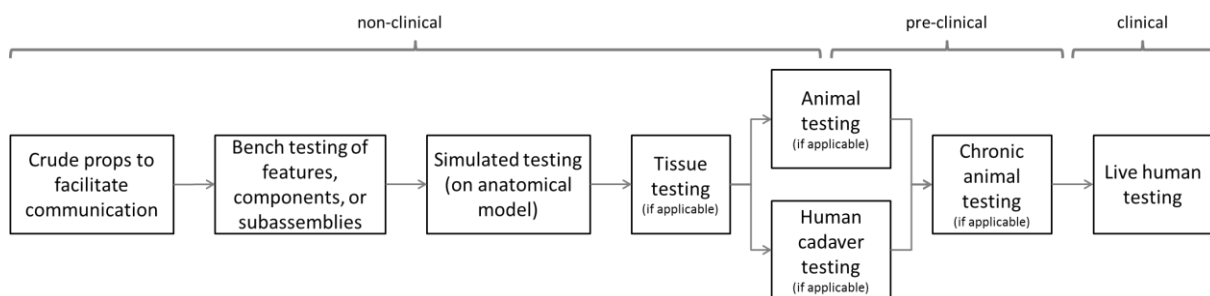

Figure 4.17: Different prototyping stages.

Clinical studies can be classified into four phases. During phase 1 trials, the device’s safety is evaluated and the side effects are identified. In phase 2, safety is further evaluated and effectiveness is determined. Phase 3 refers to final testing and phase 4 to post marketing studies.

When prototyping and design verification and validation involve users, the comments made during the description of the task ‘voice of the customer’ are equally applicable.

A supply chain refers to the network of organizations involved, both upstream (suppliers) and downstream (distributors), in the different processes and activities necessary to produce products or services that are delivered to the ultimate consumer (Mentzer et al. 2001). In the medical device sector, its design should consider potential device recalls in order to speed that process as well as helping to identify the source of the problem. Depending on the device’s hazard degree and the extent of distribution (e.g. distributors, hospitals, alternate care locations, or patient) a dedicated strategy should be defined. In any case, there are some aspects that are essential, namely the enterprise resource planning (ERP) system, the warehouse management system (WMS), and the traceability of the lot and the serial number.

During the design stage a hazard analysis (Figure 4.18) aims to mitigate the device’s hazards, gather information to be used in the instructions for use, and prepare post-market surveillance activities. A tool typically used in this sub process is failure modes and effects analysis (FMEA) (Dyadem Press 2003; Nelson and Eubanks 2005).

FMEA is defined in the standard IEC 60812 as ‘a systematic procedure for the analysis of a system to identify the potential failure modes, their causes, and effects on the system performance’. Although this tool is suitable for risk analysis, it is not a standalone risk management system nor does

it provide all the required inputs for a risk analysis (Krenc 2010). Hence, should be considered additional tools, such as failure modes effects and criticality analysis (FMECA), preliminary hazard analysis (PHA), and fault tree analysis (FTA).

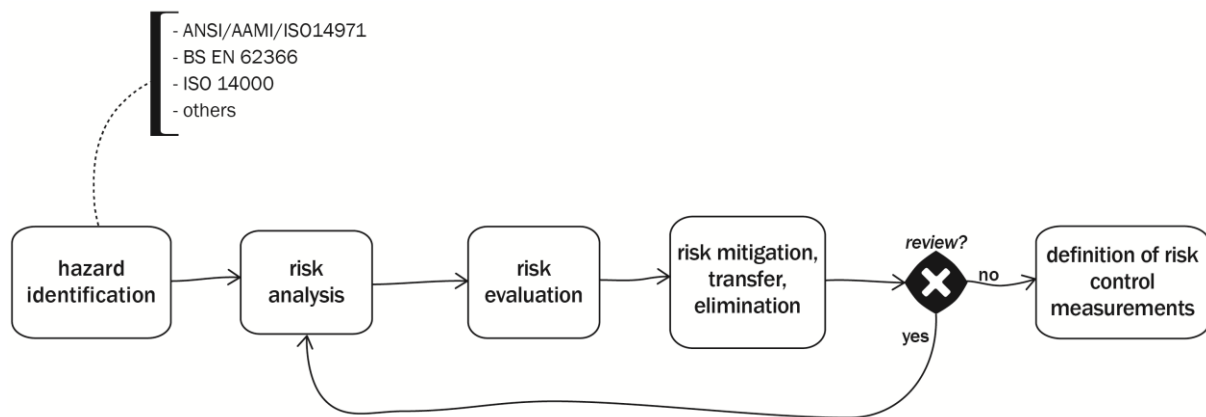

Figure 4.18: The hazard analysis sub process.

4.4.4 Regulatory approval and clearance

The approval process differs from country to country and according to the device's risk classification. Both the European and North American processes are described in section 2.5.

4.4.5 Post-market activities

Once a medical device enters the market, the design team changes its focus to the device's continual improvement regarding both manufacture and design, and the development of new versions for the device.

Manufacturers, besides being responsible for post-market surveillance, can collect data to carry out the economic analyses typically performed in HTA and calculate the device's actual risk.

The assessment process of healthcare technologies varies depending on what is being evaluated, by whom, and for what purpose (O'Reilly et al. 2009). Generally, the first step is the selection of the type of analysis and its point of view (societal, healthcare provider, or patient). Then, it is necessary to understand how the device is used; that is, if it is used alone or in a medical procedure. Following, competitor products or procedures are identified, and data regarding the clinical need, incidence rate, benefits and consequences are gathered. Finally, results are displayed and interpreted.

When dealing with a recall, there are four different attitudes: denial, involuntary recall or forced compliance, voluntary recall, and 'super-effort' (Chen et al. 2009). At one extreme, companies deny any responsibility and delay the process, while in the other extreme, companies act early issuing voluntary recalls and communicating extensively with the stakeholders. Although proactive strategies influence positively consumers, in fact, they hurt the company's financial value. Nonetheless, regardless of the nature of the strategy adopted, companies should plan ahead.

4.5 Chapter takeaways

Although there is diverse information about the DPMD, it is not effortlessly found by those new to the topic. That associated with repeated medical device recalls shows that there is a gap. To fill such gap, it was proposed a dedicated development process for medical devices giving special attention to its graphic representation. The proposed methodology aims to provide a mental framework and guidelines to assist the development any medical device.

The methodology was presented in scientific conferences and received a positive feedback. However, it was not yet applied in the design of a new device and its versatility and limitations were not discussed. Notice that, as the NPD process is unrepeatably, it is impossible to validate the methodology. Nonetheless, if it is followed resulting in a high number of commercial successes, it can be considered as a good practice.

As far as the presentation of the methodology is concerned, a modeling language was used. The multiple phases were represented in a poster, but this support should be reconsidered to ensure a widespread use. An alternative could be a digital application that allowed to zoom in and zoom out and also included information about each task.

5 Study case: Smart stent-graft

5.1 Introduction

Although the development of a new product is a unique process, this chapter describes the development process of a medical device using two distinct methodologies. The main purpose was to apply the proposed methodology and show its advantages when compared with a generic new-product development methodology.

After the description of the medical condition, aortic aneurysms, it is presented the development of a smart stent-graft using a commonly accepted product development methodology. Then, the proposed methodology is presented.

This chapter contains work and results presented in the book chapter 'Improving post-EVAR surveillance with a smart stent-graft' by Isa C.T. Santos, Alexandra T. Sepulveda, Júlio C. Viana, António J. Pontes, Brian L. Wardle, S. M. Sampaio, R. Roncon-Albuquerque, João Manuel R.S. Tavares, L.A. Rocha published in the book 'Technologies for medical sciences' (Springer, 2012).

5.2 Background

In 1948, Albert Einstein was diagnosed with an abdominal aortic aneurysm (AAA or triple A), i.e., his aorta had a permanent and irreversible localized dilatation having at least a 50% increase in diameter compared with the normal one (Johnston et al. 1991) (Figure 5.1). Like him, currently, it is estimated that more than 12 per 100 000 persons-year (Ricotta et al. 2009) are affected by this relatively indolent but serious condition.

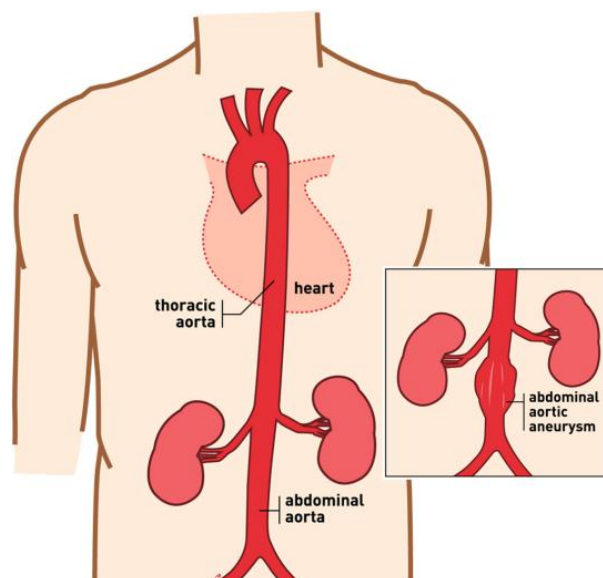

Figure 5.1: Representation of a normal aorta and an abdominal aortic aneurysm (AAA or triple A).

In an attempt to reinforce the aortic wall and delay the inevitable rupture that took Einstein’s life in 1955, Dr. Rudolph Nissen wrapped the visible anterior portion of the aneurysm with polyethylene cellophane. However, nowadays there are more effective treatments (Figure 5.2), namely open surgery, laparoscopy or assisted laparoscopy, and endovascular aneurysm repair (EVAR). The treatment is selected considering the technology available in the medical center, the anatomy of the aneurysm, the operative risk of repair and the patient’s life expectancy.

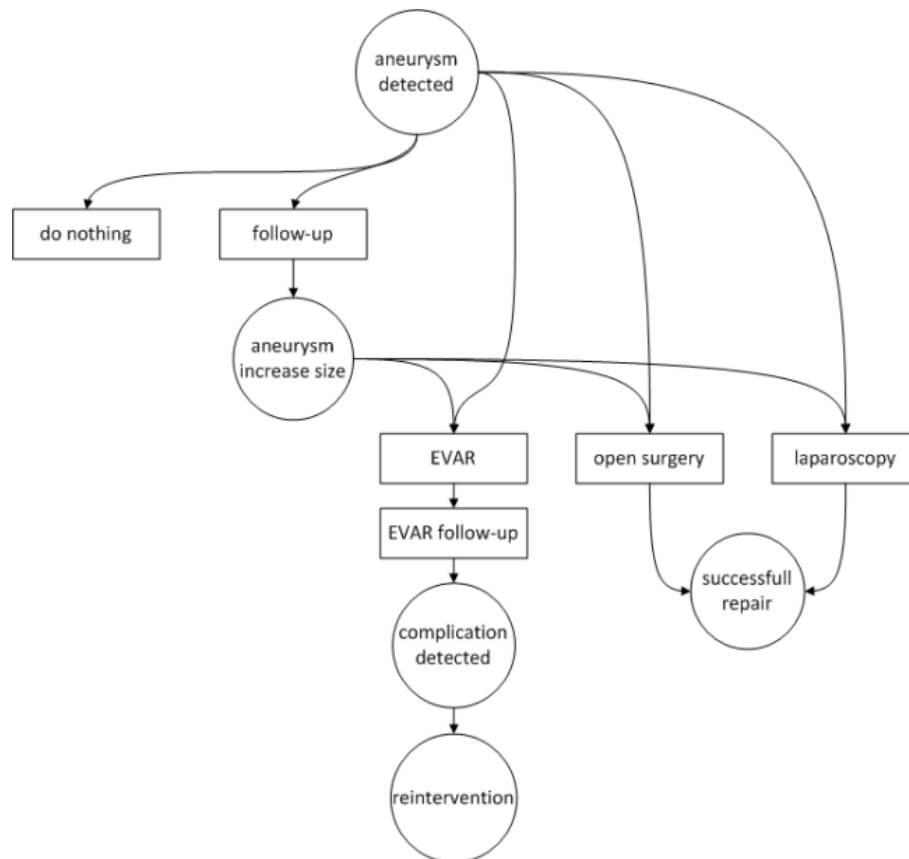

Figure 5.2: Management of aortic aneurysms; circles represent events while rectangles represent actions.

Open surgery is an invasive procedure in which the diseased segment of the aorta is replaced by a synthetic graft. Total laparoscopy and assisted laparoscopy are two recent minimally invasive procedures with similar purposes to those of open surgery (Milner et al. 2006). EVAR was introduced in the early 1990s and is a minimally invasive procedure in which an endoprosthesis – a stent-graft – is guided from the femoral artery to the affected artery segment. The objective of this procedure is to shield the aneurysm sac from the blood pressure, thus preventing the rupture of the artery wall. Although this technique is associated with advantages such as shortened hospital stays, accelerated recovery and early return to full activity, complications still occur (Table 5.1), requiring life-long surveillance of patients (Katzen and MacLean 2006). The current surveillance protocol involves imaging exams, namely ultrasound and computed tomography angiography (CTA), at 1, 6, and 12 months after the procedure, and thereafter, on an annual basis (Milner et al. 2006).

The introduction of EVAR revolutionized the treatment of aortic aneurysms by allowing more patients to be treated. However, after 20 years of use, questions are being raised regarding the follow-up costs (Young et al. 2010). Thus, in order to reduce EVAR’s follow-up costs it was suggested

the development of a smart stent-graft, i.e. a stent-graft with some in-device mechanism to perform a given function with communication capabilities to an external element.

Table 5.1: Usual complications involving stent-grafts (adapted from (Katzen and MacLean 2006)).

Early complications	Late complications
Graft kink	Graft migration
Endoleaks	Neck dilatation
Graft explantation	Endoleaks
Structural failure	Structural failure: component separation, fabric tears, hook fractures
Graft infection	

5.3 Before the new development methodology

The development of the novel smart stent-graft was conducted by a research group composed by scientists and students of three Portuguese universities in the framework of the MIT-Portugal Program. The project (starting date: August 2009; ending date: January 2013) aimed to study new materials for endovascular applications, to develop a flexible sensing technology, and to prove the feasibility of a smart stent-graft. Here, only the latter will be addressed.

The design of the smart stent-graft was carried out concurrently with the study of new materials and the development of the new technology. Its planning considered the product development methodology described by Ulrich et al. (Ulrich and Eppinger 2011) and is summarized in Figure 5.3.

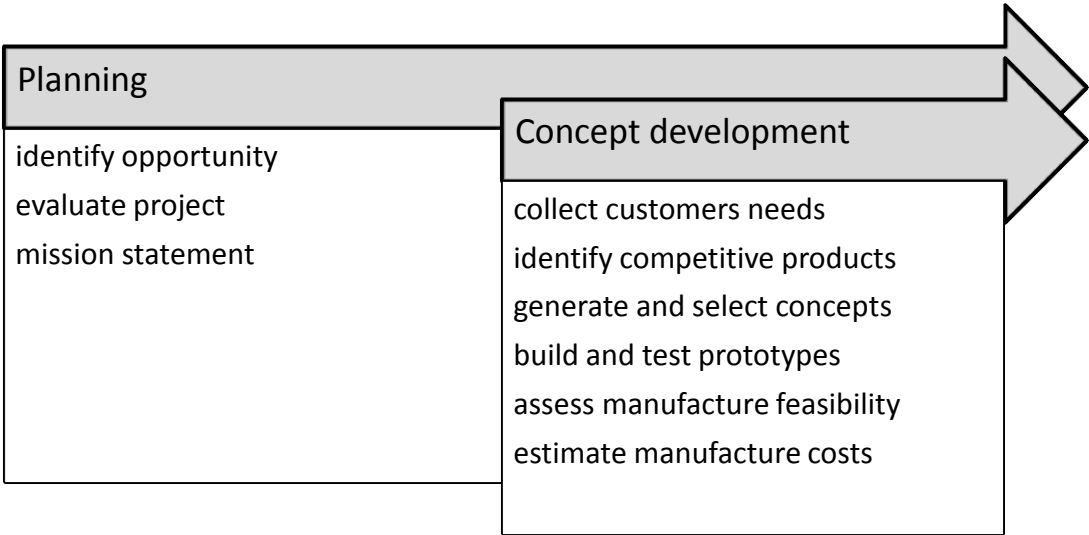

Figure 5.3: Planning of the development of the smart stent-graft.

The opportunity had been identified earlier and it was to reduce EVAR’s follow-up costs. The project’s mission statement is presented in Table 5.2.

With the definition of the mission statement, the concept development phase began. The medical condition was studied, and the existing stent-grafts were identified and described. To identify new stent-grafts designs, patents, and scientific journals were reviewed.

Table 5.2: Mission statement regarding the development of the smart stent-graft.

Product description	A stent-graft with a sensing mechanism to perform a given function (e.g., measure intraluminal pressure) with communication capabilities to an external element
Key business goals	Develop a proof of concept
Assumptions and constrains	Improve the performance of the current stent-grafts applying different materials Apply a flexible sensing technology
Stakeholders	Vascular surgeons and physicians Patients with aortic aneurysms

The requirements for the new device were gathered by reviewing the literature, and conducting surveys and interviews. The literature provided information about the disease and its incidence as well as the most common causes of device’s failure and suggestions for future research. The surveys were administered to patients and healthcare professionals, and aimed to identify the stent-graft’s characteristics and the customer’s willingness to adopt a smart device.

The questionnaire to healthcare professionals was prepared in the internet in English and Portuguese. Between June 2010 and February 2011, links to the surveys were available in a blog specifically created to divulge the project, but no answers were obtained. The link was then sent by email to several vascular surgeons and physicians, and 65 answers were gathered.

The answers came from Europe, North America, and Africa, and the majority of the respondents (77%) was never involved in the development of a medical device. The factors considered in the selection of a stent-graft and their relevance are displayed in Figure 5.4.

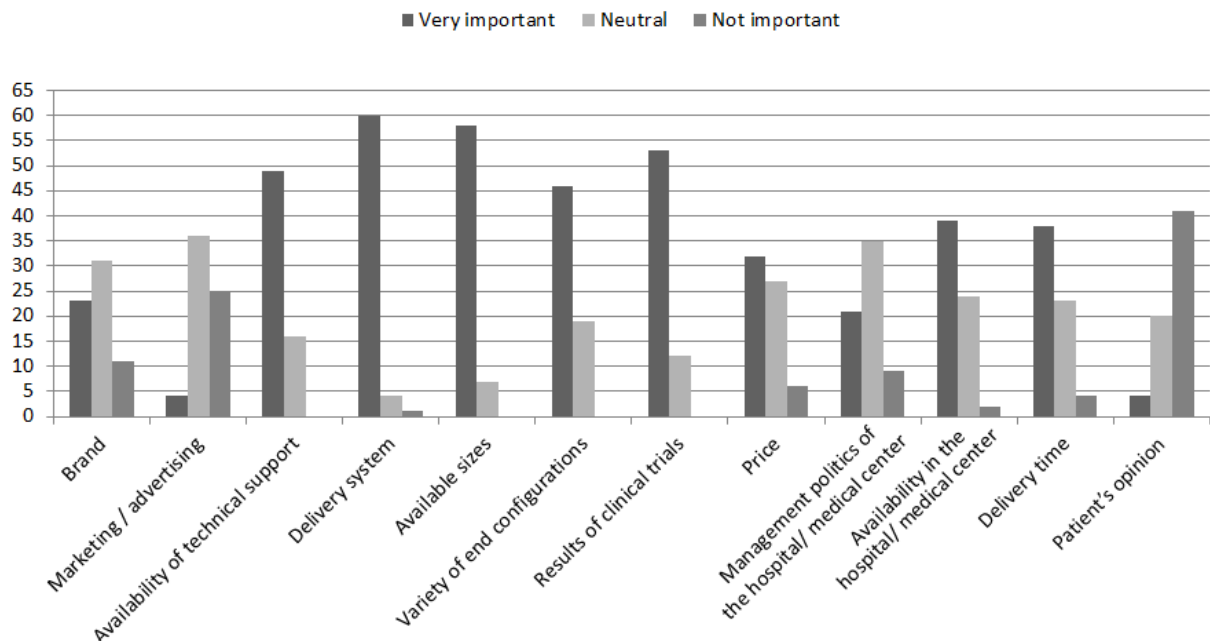

Figure 5.4: Criteria considered during the selection of a stent-graft and their relevance. Question: When selecting a stent-graft, what is the relevance of the following factors?; Total answers: 65.

To the question ‘What do you value in a stent-graft?’, the respondents answered that they value most flexibility, fixation, and the delivery profile (Figure 5.5). These answers were consistent with the ones given to the open question ‘What changes would you introduce in the stent-grafts that you use?’.

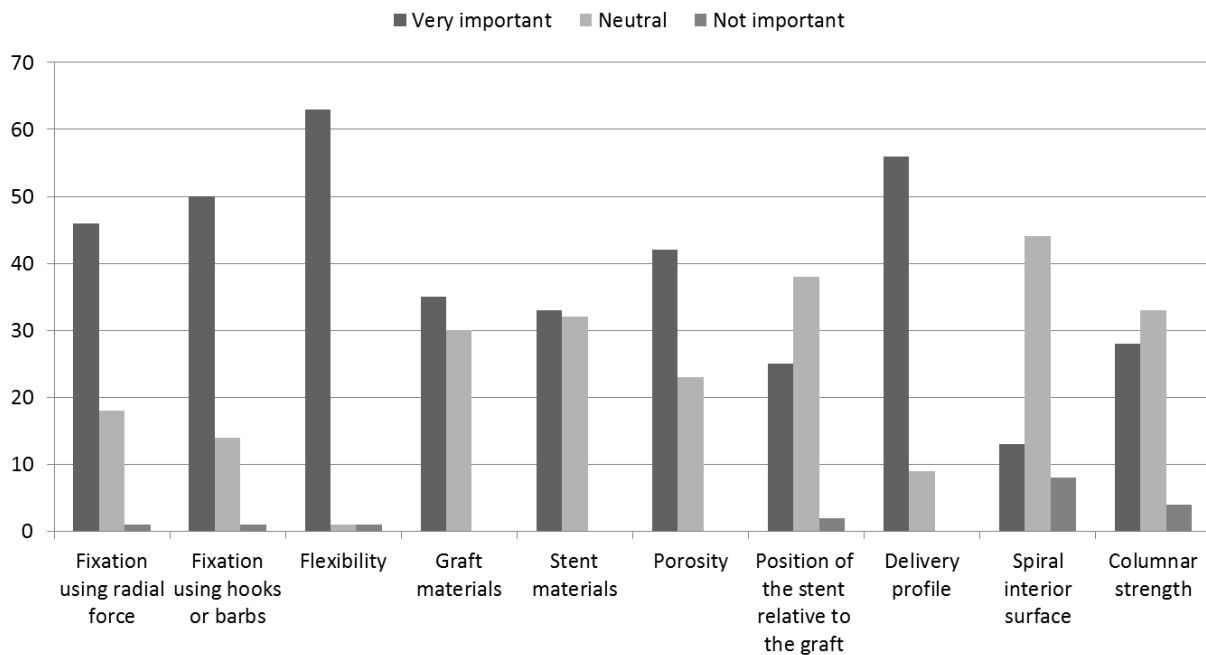

Figure 5.5: Valuation of the stent-graft's characteristics.
 Question: What do you value in a stent-graft?; Total answers: 65.

Presently, surveillance protocols require imaging at 1, 6, and 12 months after the procedure, and thereafter on an annual basis (Milner et al. 2006). The respondents of this survey do not follow this protocol; they adopted one with different exam periodicities. However, they consider the exam process that they follow effective, reliable, and practical (Figure 5.6).

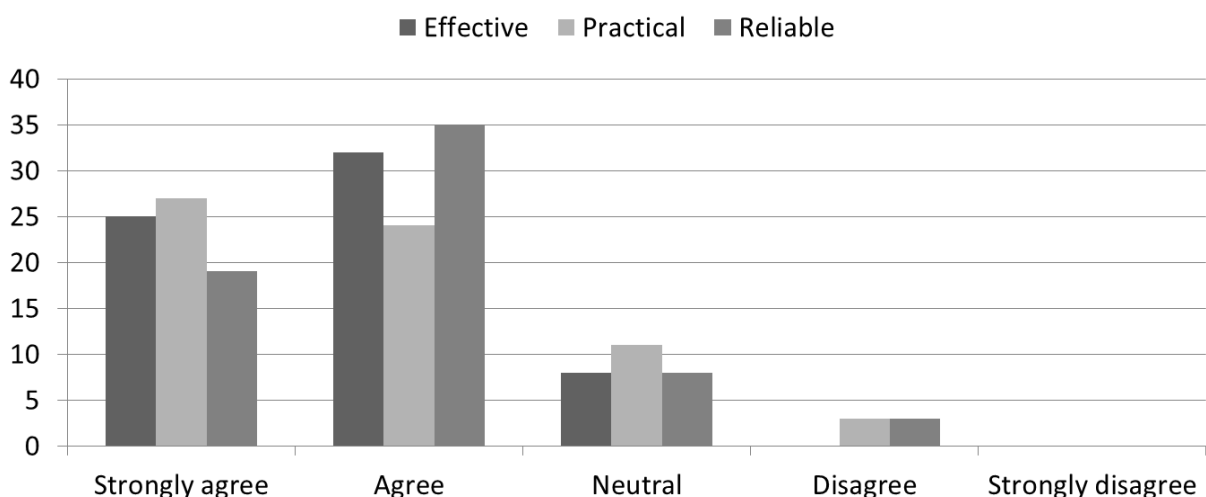

Figure 5.6: Description of the EVAR follow-up protocol.
 Question: How would you describe the exam process?; Total answers: 65.

As far as the identification of complications is concerned, the results do not indicate a trend (Figure 5.7) but the majority of the respondents (83%) considers the use of a smart stent-graft advantageous and would like to obtain information about the stent-graft migration (Figure 5.8).

Like the questionnaire to the healthcare professionals, the survey to patients was prepared in the internet in English and Portuguese. The links were available in the blog, but no answers were obtained. Thus, three Portuguese hospitals with vascular surgery were contacted to administer the

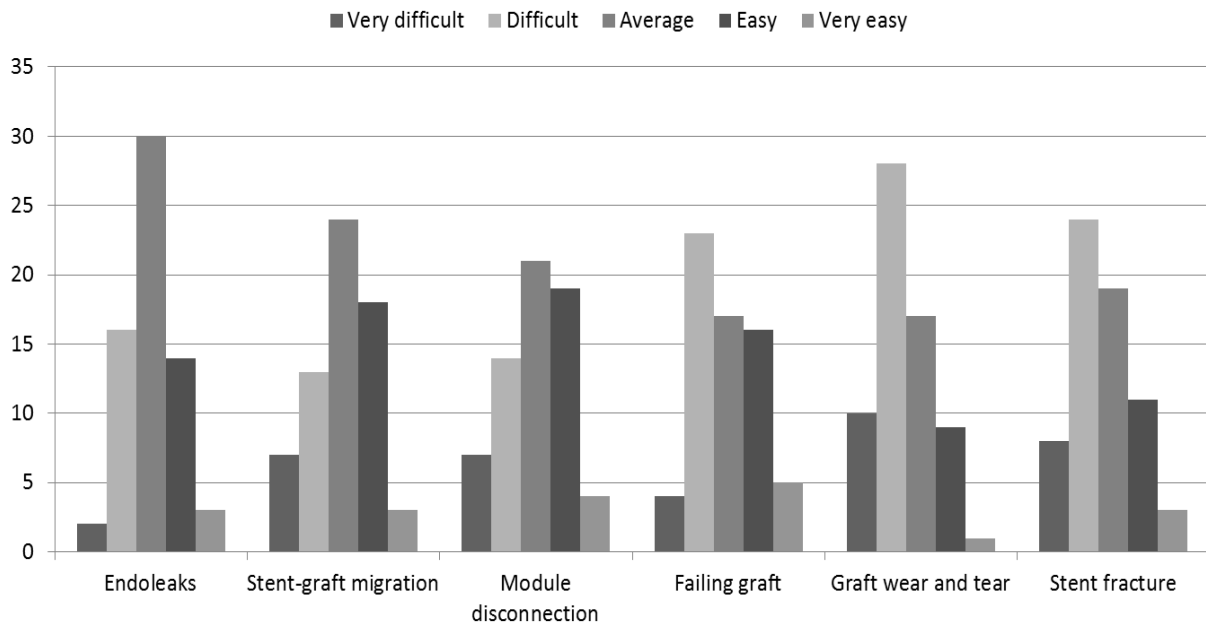

Figure 5.7: Difficulty in the detection of complications.
 Question: How would you classify the identification of the following problems?; Total answers: 65.

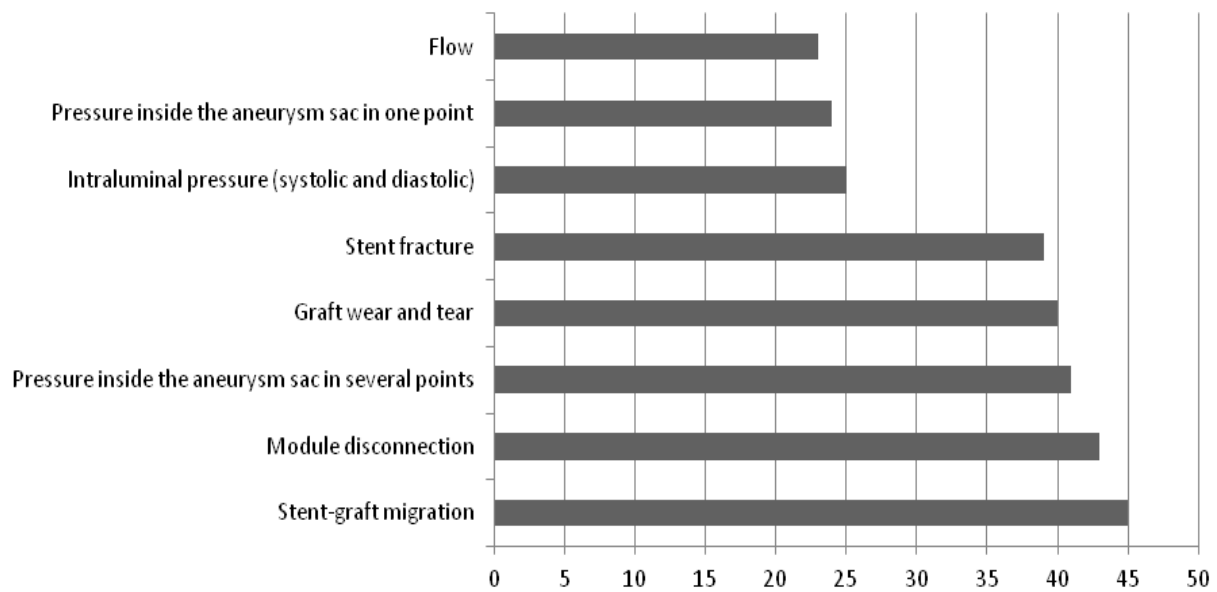

Figure 5.8: Information provided by a smart stent-graft.
 Question: Which information would you like to obtain from a stent-graft?; Total answers: 65.

survey to their patients (Figure 5.9). To interact with patients, the three hospitals required that the questionnaire was approved by the Ethics Committee, a process that took about a year to conclude. Upon approval, the patients of H.S. João and HUC were interviewed while waiting for their appointment. In the latter, some questionnaires were filled during the appointment with the doctor. At H.S. Marta, no answer was received.

From the 87 patients questioned, only 21 had an aneurism in the aorta (either thoracic or abdominal). Every patient said that the surgeon decided the treatment and which stent-graft should be used. Although the majority (86%) was not afraid of performing imaging exams, it did not feel comfortable while doing them (76%). 95% of the respondents would ask his doctor for a smart stent-graft.

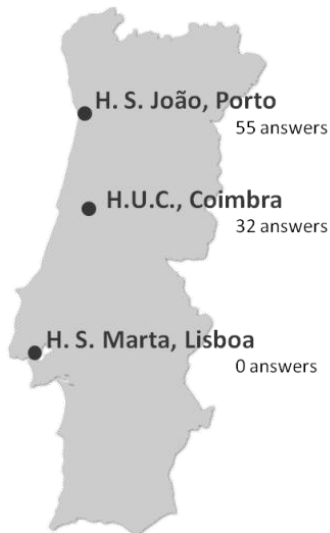

Figure 5.9: Hospitals contacted to administer the surveys to patients and the number of responses obtained.

The requirements gather during the literature review, and the surveys were then classified in accordance with the Kano Model; the results are summarized in Table 5.3.

Table 5.3: Requirements for the smart stent-graft

Must-be	<ul style="list-style-type: none"> Biocompatible and biostable Nontoxic, allergic and carcinogenic Not cause thrombosis and hemolysis Not cause inflammatory reaction or foreign body reaction Exceed patient life expectancy Flexible, ductile and fatigue resistant Stable configuration Resistant to corrosion, wear and tear Radial force that ensures fixation and avoids leaks Radiopaque Sterilizable Storable as an 'off-the-shelf' product Manufacture environmentally accepted
Satisfier	<ul style="list-style-type: none"> Zero porosity Predictable behavior Wide range of diameters and lengths Low profile
Delighter	<ul style="list-style-type: none"> Minimizes flow resistance and pressure drops Indicates the intraluminal pressure (systolic and diastolic) Indicates the pressure inside the aneurysm sac at several points Indicates if stent-graft migrates Indicates if module disconnects Indicates stent fractures Indicates if graft tears Indicates blood flow

The following steps would involve the generation of concepts to meet the customer's needs, specifically the selection of technologies able to meet the requirements classified as 'delighters'. However, the new-device development process was abandoned in spite of the research concerning

new materials for endovascular applications, and the development of a flexible sensing technology continued.

5.4 After the new development methodology

The design team involved in the work described in the previous section was the same that applied the proposed technology. In spite of having learned with the previous work, the team tried to act as if they were addressing the problem for the first time.

The first step was the adaption of the proposed methodology. Instead of reviewing the entire process, it was decided to approach each phase separately. The ideation phase is represented in Figure 5.10 and Table 5.4 presents the project’s mission statement.

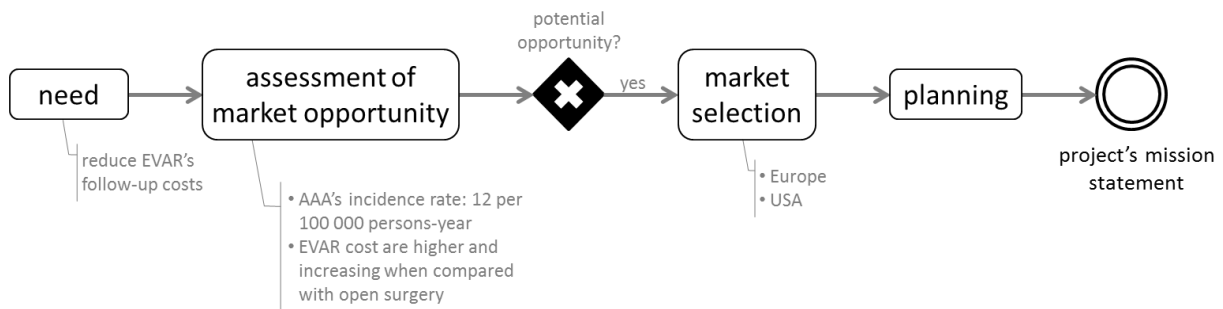

Figure 5.10: The adapted ideation phase.

Table 5.4: Project’s mission statement.

Description of the problem	EVAR requires follow-up procedures
Market opportunity	Reduce EVAR follow-up costs
Key business goals	Develop a proof of concept
Markets	Europe and USA

As the medical condition had been studied previously, the concept development phase began with the analysis of competitor products.

Laparoscopy is among AAA’s possible treatments and, like EVAR, is a minimally invasive procedure but, unlike EVAR, does not require life-long surveillance. The technology that enables this procedure is still new but, as time goes by, it will become cheaper and user-friendly. Laparoscopy is appealing to doctors because, besides being ‘cool’, avoids the use of contrast dye and radiation. Considering the alternative treatment, EVAR will become obsolete. Thus, the development of a smart stent-graft was abandoned.

5.5 Chapter takeaways

This chapter described two development processes: one that applies a commonly accepted

product development methodology and the other that applies the proposed methodology dedicated to medical devices. In both cases the same decision was made but at different times. With the first, the project was abandoned before concept generation, nearly two years after the project's inception, while with the second the decision was made during the analysis of competitor products. It is a fact that the team learned with the first process but still the need was initially defined too narrowly.

As future work, it would be interesting to present the problem to two design teams with similar backgrounds and access to the same resources, asking them to follow the different methodologies, the proposed and another one, in parallel aiming the comparison of the development process.

6 Conclusions and future work

6.1 Conclusions

This Thesis aimed to provide a deeper understanding on the medical device sector. Such objective was achieved by identifying the medical devices' distinctive characteristics and inferring how they influence the development process of novel devices.

The term 'medical device' encompasses a wide range of products which, to enter the market, have to comply with strict regulatory frameworks that vary from country to country or economic region. In addition, the development process, diffusion, and adoption of medical devices go beyond science as they involve as well ethics and economics. Some of the peculiarities identified here are not exclusive to medical devices but taken all together they suggest that the medical device industry is complex and would benefit from a dedicated new-product development methodology to guide the development process. In addition, it would not be bold to say that medical devices should be addressed as an independent research topic and not as a branch of mechanical or biomedical engineering.

It is commonly accepted that resorting to new-product development processes, products get to the market faster giving companies a competitive advantage and better financial return. However, the revision of the literature revealed, on the one hand, that current new-product development methodologies do not address topics of significance to medical devices, and on the other hand, the few publications available on the theme focus on just one topic. Hence, there is a gap on the overall understanding of the development process of medical devices. To fill such gap it was proposed a dedicated methodology comprising the following stages: ideation, concept development, design, regulatory approval, and post-market activities.

Overall, considering the medical devices peculiarities, the tasks that should be performed in each stage were described, and some tools were also suggested. For example, considering the relevance of health technology assessment in the medical device's lifecycle, it was proposed a novel concept selection tool based on the expected value of the concepts.

In this project, there was a special concern on how information should be presented and communicated. Thus, a modeling language was used to facilitate the implementation of the methodology as software applications. Posters were also prepared, but in spite of facilitating the diffusion of information, this format revealed itself unpractical due to the large amount of information involved.

Due to the unrepeatability of new-product development, the proposed methodology was not fully validated. Nevertheless, it was applied in the development of a smart stent-graft and, when compared to a commonly accepted new-product development methodology, it proved to be more efficient. In both cases, the development of the smart stent-graft was abandoned; while with the proposed methodology, the project was abandoned during the review of the state of the art, with the other methodology, the project was abandoned after consuming considerable resources, during

the step of concept generation.

Although it is expected that laparoscopy will make endovascular procedures obsolete, the following information was gathered:

- there is a need to reduce the costs of the treatment of aortic aneurysms;
- the delivery system, the available sizes, and the results in clinical trials are the three most relevant factors considered in the selection of a stent-graft;
- in a stent-graft, surgeons value the flexibility, the delivery system, and the fixation;
- surgeons have difficulties in identifying endoleaks and graft wear and tear;
- most surgeons considered a smart stent-graft advantageous and would like to obtain information on device migration, module disconnection, and pressure inside the aneurysm sac in several points;
- Portuguese patients trust the surgeons' decision and would accept to use a smart stent-graft.

6.2 Future work

Several paths of research can be taken in order to extend the findings achieved by this Thesis. The most pressing one is the discussion of the versatility and limitations of the proposed methodology. In this case, multiple devices with varied complexity should be developed and the time to market, the development costs, the complication rate as well as the number of devices sold should be analyzed.

The presentation of the methodology should be addressed as well. Initially, it was thought to present the methodology in a poster so it could be always visible and easily consulted but, considering the amount of information and detail, a computational application that allows zoom in and zoom out would be more appealing. If such application would be available, it could be used to support management and, in that case, further studies would be needed to identify the software's inputs and outputs, specifically which documents should to be generated and what information they should contain.

Other possible topics of research include:

- how medical devices and their development process should be taught;
- what are the differences and similarities of medical devices and borderline products;
- how costs evolve during the development process of a medical device;
- how cost-effectiveness evolves over time;
- which tools are more adequate to use in the development of medical devices;
- which intelligent decision techniques can be used to support the development of medical devices.

Bibliography

- AAMI Association for the Advancement of Medical Instrumentation (2009) ANSI/AAMI HE 75:2009 Human factors engineering — Design of medical devices.
- AAMI Association for the Advancement of Medical Instrumentation (2001) ANSI/AAMI HE 74:2001 Human factors design process for medical devices. 48.
- AdvaMed (2009) Code of ethics on interactions with medical professionals.
- Aguwa CC, Monplaisir L, Sylajakumari PA, Muni RK (2010) Integrated fuzzy-based modular architecture for medical device design and development. *Journal of Medical Devices* 4:031007. doi: 10.1115/1.4002323
- Aitchison GA, Hukins DWL, Parry JJ, et al. (2009) A review of the design process for implantable orthopedic medical devices. *The open biomedical engineering journal* 3:21–7. doi: 10.2174/1874120700903010021
- Alexander K, Clarkson PJ (2002) A validation model for the medical devices industry. *Journal of Engineering Design* 13:197–204. doi: 10.1080/09544820110108890
- Altenstetter C (1996) Regulating healthcare technologies and medical supplies in the European Economic Area. *Health policy (Amsterdam, Netherlands)* 35:33–52.
- Altenstetter C (2003) EU and member state medical devices regulation. *International journal of technology assessment in health care* 19:228–48.
- Anand K, Saini S, Singh B, Veermaram C (2010) Global medical device nomenclature: the concept for reducing device-related medical errors. *Journal of young pharmacists : JYP* 2:403–9. doi: 10.4103/0975-1483.71637
- Appleby J, Devlin N, Parkin D (2007) NICE's cost effectiveness threshold. *BMJ (Clinical research ed)* 335:358–9. doi: 10.1136/bmj.39308.560069.BE
- Arntzen-Bechina AA, Leguy CA. (2007) A model of knowledge sharing in biomedical engineering: Challenges and requirements. *Journal of Business Chemistry* 4:21–32.
- Arrow KJ (1963) Uncertainty and the welfare economics of medical care. *The American economic review* 53:941–973.
- Barclay I, Holroyd P, Poolton J (1994) A sphenomorphic model for the management of innovation in a

- complex environment. *Leadership & Organization Development Journal* 15:33–44. doi: 10.1108/01437739410066504
- Beebe HG, Cronenwett JL, Katzen BT, et al. (2001) Results of an aortic endograft trial: Impact of device failure beyond 12 months. *Journal of Vascular Surgery* 33:55–63. doi: 10.1067/mva.2001.111663
- Best M (2004) Ignaz Semmelweis and the birth of infection control. *Quality and Safety in Health Care* 13:233–234. doi: 10.1136/qshc.2004.010918
- Beyer H, Holtzblatt K (1997) Contextual design: defining customer-centered systems. 496.
- Boehm BW (1988) A spiral model of software development and enhancement. *Computer* 21:61–72. doi: 10.1109/2.59
- Boriani G, Burri H, Mantovani LG, et al. (2011) Device therapy and hospital reimbursement practices across European countries: a heterogeneous scenario. *Europace : European pacing, arrhythmias, and cardiac electrophysiology : journal of the working groups on cardiac pacing, arrhythmias, and cardiac cellular electrophysiology of the European Society of Cardiology* 13 Suppl 2:ii59–65. doi: 10.1093/europace/eur080
- Boynton PM, Greenhalgh T (2004) Selecting, designing, and developing your questionnaire. *BMJ (Clinical research ed)* 328:1312–5. doi: 10.1136/bmj.328.7451.1312
- Bradley R, Teixeira MB. (2002) *Design controls for the medical device industry*. CRC Press, New York, New York, USA
- Briol P (2008) *BPMN the business process modeling notation*. Object Management Group (OMG)
- Brown DS, Motte S (1998) Device design methodology for trauma applications. *Proceedings of the SIGCHI conference on Human factors in computing systems - CHI '98*. ACM Press, New York, New York, USA, pp 590–594
- Browning TR, Fricke E, Negele H (2006) Key concepts in modeling product development processes. *Systems Engineering* 9:104–128. doi: 10.1002/sys.20047
- BSI, DEKRA/KEMA, LNE/G-MED, et al. (2011) *Code of conduct for notified bodies - version 2.7*. 7:1–24.

- Buonomano D (2011) *Brain bugs - How the brain's flaws shape our life*. WW Norton & Company, New York, New York, USA
- Busse R, Geissler A, Quentin W, Wiley M (2011) Diagnosis-related groups in Europe. 538.
- Cadle J, Paul D, Turner P (2010) *Business analysis techniques: 72 essential tools for success*. 285.
- Cain M, Mittman R (2002) Diffusion of innovation in health care. 29.
- Chan L-K, Wu M-L (2002) Quality function deployment: A literature review. *European Journal of Operational Research* 143:463–497. doi: 10.1016/S0377-2217(02)00178-9
- Charnley F, Lemon M, Evans S (2011) Exploring the process of whole system design. *Design Studies* 32:156–179. doi: 10.1016/j.destud.2010.08.002
- Chen Y, Ganesan S, Liu Y (2009) Does a firm's product-recall strategy affect its financial value? An examination of strategic alternatives during product-harm crises. *Journal of Marketing* 73:214–226. doi: 10.1509/jmkg.73.6.214
- Chuter T a M (2002) Stent-graft design: the good, the bad and the ugly. *Cardiovascular surgery* (London, England) 10:7–13.
- Clinical Device Group (2012) Clinical Device Group. <http://clinicaldevice.com/>. Accessed 6 Jun 2012
- Collins P (2004) Sweet elixir of death. *New Scientist* 183:48–49.
- Cookson R, Hutton J (2003) Regulating the economic evaluation of pharmaceuticals and medical devices: a European perspective. *Health Policy* 63:167–178.
- Cooper RG (2008) Perspective: The stage-gate[®] idea-to-launch process—Update, what's new, and nexgen systems. *Journal of Product Innovation Management* 25:213–232. doi: 10.1111/j.1540-5885.2008.00296.x
- Cooper RG (1990) Stage-gate systems: A new tool for managing new products. *Business Horizons* 33:44–54. doi: 10.1016/0007-6813(90)90040-I
- Cosh E, Girling A, Lilford R, et al. (2007) Investing in new medical technologies: A decision framework. *Journal of Commercial Biotechnology* 13:263–271. doi: 10.1057/palgrave.jcb.3050062
- Couto DS, Perez-Breva L, Saraiva P, Cooney CL (2012) Lessons from innovation in drug-device

- combination products. *Advanced Drug Delivery Reviews* 64:69–77.
- Davey S, Anderson J, Meenan B (2005) An overview of current classification systems for healthcare devices and their limitations. 57.
- Davis S, Gilberton E, Goodall S (2011) EU medical device approval safety assessment. 15.
- Directorate General Health & Consumers (2010) Guidance MEDDEVs.
http://ec.europa.eu/health/medical-devices/documents/guidelines/index_en.htm. Accessed 7 Jun 2012
- DoD (2011) Manufacturing readiness level (MRL) deskbook.
- Drummond M, Griffin A, Tarricone R (2009) Economic evaluation for devices and drugs--same or different? *Value in health : the journal of the International Society for Pharmacoeconomics and Outcomes Research* 12:402–4. doi: 10.1111/j.1524-4733.2008.00476_1.x
- Dyadem Press (2003) *Guidelines for Failure Modes and Effects Analysis for Medical Devices*. CRC Press, Ontario, Canada
- Eatock J, Dixon D, Young T (2009) An exploratory survey of current practice in the medical device industry. *Journal of Manufacturing Technology Management* 20:218–234. doi: 10.1108/17410380910929637
- El-Haik B, Mekki KS (2008) Medical device design for six sigma: A road map for safety and effectiveness. 528. doi: 10.1002/9780470264003
- Emergo Group (2012) Emergo Group. <http://www.emergogroup.com/>. Accessed 6 Jun 2012
- Epicom Healthcare Intelligence (2012) The medical device market: USA. 102.
- Eucomed (2012) Eucomed. <http://www.eucomed.be/>. Accessed 12 Sep 2012
- EUCOMED What medical technology exactly is. <http://www.eucomed.org/medical-technology>. Accessed 4 Jan 2012
- European Commission (2011) NANDO web site.
<http://ec.europa.eu/enterprise/newapproach/nando/>. Accessed 5 May 2011
- European Union (2012) Enterprise and Industry thematic site on EUROPA - Harmonised standards.

http://ec.europa.eu/enterprise/policies/european-standards/harmonised-standards/index_en.htm. Accessed 3 Apr 2012

European Union (2011) European databank on medical devices - EUDAMED.

<http://ec.europa.eu/consumers/sectors/medical-devices/market-surveillance-vigilance/eudamed/>. Accessed 27 Jun 2011

Fairlie-Clarke T, Muller M (2003) An activity model of the product development process. *Journal of Engineering Design* 14:247–272. doi: 10.1080/0954482031000091040

FDA (2012a) FDA - Product classification.

FDA (2011a) Devices@FDA: Medicinal leeches.

<http://www.accessdata.fda.gov/scripts/cdrh/devicesatfda/index.cfm?db=pmn&id=K040187>. Accessed 26 May 2011

FDA (2012b) FDA - Device classification.

<http://www.accessdata.fda.gov/scripts/cdrh/cfdocs/cfPCD/classification.cfm>. Accessed 9 Jul 2012

FDA (2011b) FDA - Medical devices. <http://www.fda.gov/MedicalDevices/default.htm>. Accessed 4 May 2011

FDA (2011c) Manufacturer and User Facility Device Experience Database - MAUDE.

FDA (2012c) FDA - List of device recalls.

<http://www.fda.gov/MedicalDevices/Safety/ListofRecalls/default.htm>. Accessed 12 Jul 2012

FDA (2012d) FDA - Recalls, corrections and removals (devices).

<http://www.fda.gov/MedicalDevices/DeviceRegulationandGuidance/PostmarketRequirements/RecallsCorrectionsAndRemovals/default.htm>. Accessed 12 Jul 2012

FDA (1997) Design control guidance for medical device manufacturers. History 53.

FDA (2010) Medical & Radiation Emitting Device Recalls.

<http://www.accessdata.fda.gov/scripts/cdrh/cfdocs/cfRES/res.cfm?id=95390>. Accessed 5 Aug 2012

Fries RC (2001) Handbook of medical device design. 774.

- Fries RC (2006) *Reliable design of medical devices*, 2nd ed. 504.
- Frost & Sullivan Research Service (2008) *Reimbursement for medical devices in Western European markets*.
- Fuchs S, Sandmann C, Gerdemann G, et al. (2004) Quality of life and clinical outcome in salvage revision total knee replacement: hinged vs total condylar design. *Knee surgery, sports traumatology, arthroscopy : official journal of the ESSKA* 12:140–3. doi: 10.1007/s00167-003-0401-8
- Gad SC, McCord MG (2008) *Materials in medical device design. Safety evaluation in the development of medical devices and combination products*, 3rd ed. Informa Healthcare, pp 49–61
- Gameran GE (1992) FDA regulation of biomedical software. *Proceedings / the . Annual Symposium on Computer Application [sic] in Medical Care Symposium on Computer Applications in Medical Care* 745–9.
- GHTF (2011) GHTF: Global Harmonization Task Force. www.gh tf.org. Accessed 25 May 2011
- GMDN Agency (2011) GMDN homepage. <http://www.gmdnagency.com/Default.aspx>. Accessed 5 Jul 2011
- Gold MR, Siegel JE, Russell LB, Weinstein MC (1996) *Cost-effectiveness analysis in health and medicine*. Oxford University Press, USA
- Goodson L, Vassar M (2011) An overview of ethnography in healthcare and medical education research. *Journal of educational evaluation for health professions* 8:4. doi: 10.3352/jeehp.2011.8.4
- Gopaldaswamy V, Justiniano J (2004) Six sigma for medical device design. doi: 10.1201/9780203485743
- Greenhalgh T, Robert G, Macfarlane F, et al. (2004) Diffusion of innovations in service organizations: systematic review and recommendations. *The Milbank quarterly* 82:581–629. doi: 10.1111/j.0887-378X.2004.00325.x
- Grocott P, Weir H, Ram MB (2007) A model of user engagement in medical device development. *International Journal of Health Care Quality Assurance* 20:484–493. doi: 10.1108/09526860710819422

Guenoun B, Latargez L, Freslon M, et al. (2009) Complications following rotating hinge Endo-Modell (Link) knee arthroplasty. *Orthopaedics & traumatology, surgery & research* : OTSR 95:529–36. doi: 10.1016/j.otsr.2009.07.013

Gupta K (2007) *A practical guide to needs assessment*, 2nd ed. Pfeiffer

Hanna KE, Manning FJ, Boussein P, Pope A (2001) *Innovation and invention in medical devices*. National Academy Press, Washington DC

Holmes DR, Firth BG, James A, et al. (2004) Conflict of interest. *American heart journal* 147:228–37. doi: 10.1016/j.ahj.2003.12.001

Holtzman Y (2008) Innovation in research and development: tool of strategic growth. *Journal of Management Development* 27:1037–1052. doi: 10.1108/02621710810916295

Hutchings A (2010) Rewarding innovation? An assessment of the factors that affect price and reimbursement status in Europe. *Journal of Medical Marketing* 10:83–90. doi: 10.1057/jmm.2009.49

International Medical Device Regulators Forum International Medical Device Regulators Forum. www.imdrf.org. Accessed 12 Sep 2012

ISO International Organization for Standardization (2007) *ISO 14971:2007 - Medical devices - Application of risk management to medical devices*. 2007:

Ison E (2000) The use of LCA to introduce life-cycle thinking into decision-making for the purchase of medical devices in the NHS. *Journal of Environmental Assessment Policy and Management* 2:453–476. doi: 10.1016/S1464-3332(00)00049-7

Johnston KW, Robert BR, Tilson MD, et al. (1991) Suggested standards for reporting on arterial aneurysms. *Journal of Vascular Surgery* 13:452–458.

Katzen BT, MacLean AA (2006) Complications of endovascular repair of abdominal aortic aneurysms: A review. *CardioVascular and Interventional Radiology* 29:935–946. doi: 10.1007/s00270-005-0191-0

Kaufman J a., Geller SC, Brewster DC, et al. (1999) The vanguard stent-graft: practical approach. *Techniques in Vascular and Interventional Radiology* 2:145–164. doi: 10.1016/S1089-2516(99)80029-8

- Kim JH, Scialli AR (2011) Thalidomide: the tragedy of birth defects and the effective treatment of disease. *Toxicological sciences : an official journal of the Society of Toxicology* 122:1–6. doi: 10.1093/toxsci/kfr088
- Klein DE, Jordan MJ (2002) Methods of assessing medical devices. *Proceedings of the Human Factors and Ergonomics Society Annual Meeting* 46:1890–1894. doi: 10.1177/154193120204602305
- Kossack MF, Gellatly a. W (2007) The what and how of medical device design validation: A human factors methodology. *Proceedings of the Human Factors and Ergonomics Society Annual Meeting* 51:750–755. doi: 10.1177/154193120705101131
- Kotler P, Keller KL (2012) *Marketing management*, 14th ed. Pearson Education Limited, Essex
- Kramer TE (2010) Design driven development: The D3 process. *Proceedings of the 2010 International Medical Device Expo IMDE 2010*
- Krenc T (2010) Risk management: it's not just FMEA. *Biomedical instrumentation & technology / Association for the Advancement of Medical Instrumentation* 44:242–4.
- Kriewall TJ, Widin GP (1991) An application of quality function deployment to medical device development. [1991 Proceedings] *Case Studies in Medical Instrument Design*. IEEE, pp 23–36
- Langford J, McDonagh D (2002) Focus groups -Supporting effective product development. doi: 10.1201/9780203302743
- Linehan JH, Paté-cornell ME, Yock PG, et al. (2007) *Medical device development models - Final Report*. Office 329.
- Lugt R van der (2000) Developing a graphic tool for creative problem solving in design groups. *Design Studies* 21:505–522. doi: 10.1016/S0142-694X(00)00021-1
- Madison D (2005) *Process mapping, process improvement, and process management*. 320.
- Maisel WH (2004) Medical device regulation: An introduction for the practicing physician. *Annals of Internal Medicine* 140:296–302.
- Mankins JC (2009) Technology readiness assessments: A retrospective. *Acta Astronautica* 65:1216–1223. doi: 10.1016/j.actaastro.2009.03.058

- Martin JL, Murphy E, Crowe J a, Norris BJ (2006) Capturing user requirements in medical device development: the role of ergonomics. *Physiological measurement* 27:R49–62. doi: 10.1088/0967-3334/27/8/R01
- Matzler K, Hinterhuber HH (1998) How to make product development projects more successful by integrating Kano's model of customer satisfaction into quality function deployment. *Technovation* 18:25–38.
- McAteer H, Cosh E, Freeman G, et al. (2007) Cost-effectiveness analysis at the development phase of a potential health technology: examples based on tissue engineering of bladder and urethra. *Journal of Tissue Engineering and Regenerative Medicine* 1:343–349. doi: 10.1002/term.36
- Mcmanus HL (2005) Product development value stream mapping (PDVSM) manual. 116.
- MEDDEV (2010) MEDDEV 2.4 - Medical devices guidance document - Classification of medical devices. Changes
- Medina L a., Kremer GEO, Wysk R a. (2012) Supporting medical device development: a standard product design process model. *Journal of Engineering Design* 1–37. doi: 10.1080/09544828.2012.676635
- Medina LA, Wysk RA, Kremer GEO (2011) An ontology model for the medical device product development. *Proceedings of the 2011 Design of Medical Devices Conference*. Minneapolis, MN, USA, pp 1–8
- Mehta SS (2008) *Commercializing successful biomedical technologies: basic principles for the development of drugs, diagnostics and devices*. Cambridge University Press, Cambridge
- Mentzer JT, DeWitt W, Keebler JS, et al. (2001) Defining supply chain management. *Journal of Business Logistics* 22:1–25. doi: 10.1002/j.2158-1592.2001.tb00001.x
- Miller BC (2012) *Quick brainstorming activities for busy managers: 50 exercises to spark your team's creativity and get results fast*. 208.
- Milner R, Kasirajan K, Chaikof EL (2006) Future of endograft surveillance. *Seminars in Vascular Surgery* 19:75–82. doi: 10.1053/j.semvascsurg.2006.03.002
- National Institute for Health and Clinical Excellence (2012) *NICE Published clinical guidelines*. <http://www.nice.org.uk/guidance/index.jsp?action=byType&type=2&status=3>. Accessed 21

May 2012

National Patient Safety Agency (2010) Design for patient safety - User testing in the development of medical devices.

Natschläger C (2011) Deontic BPMN. In: Hameurlain A, Liddle SW, Schewe K-D, Zhou X (eds) Database and Expert Systems Applications. Springer Berlin Heidelberg, Berlin, Heidelberg, pp 264–278

Nelson SR, Eubanks F (2005) Risk tools for technical development: hazard analysis and FMEA. In: Kahn KB (ed) PDMA Handbook of New Product Development, 2nd ed. John Wiley & Sons, Hoboken, New Jersey, pp 430–441

Neumann PJ (2005) Using cost-effectiveness analysis to improve health care. 224.

Newnes LB, Medland a J, Daniel J a, Holmes CH (2006) A cyclic design approach applied to a cervical screening device. Proceedings of the Institution of Mechanical Engineers, Part B: Journal of Engineering Manufacture 220:307–317. doi: 10.1243/095440506X77553

NHS National Innovation Centre (2012a) Scorecard. <http://scorecard.nic.nhs.uk/>. Accessed 6 Jun 2012

NHS National Innovation Centre (2012b) Navigator. <http://navigator.nic.nhs.uk/start.aspx>. Accessed 6 Jun 2012

NHS Supply Chain (2011) Field Safety Notice - FWX313 FWX013.
<https://www.supplychain.nhs.uk/product-news/customer-notices/2011/june/field-safety-notice-fwx313-fwx013/>. Accessed 5 Aug 2012

Nobel JJ (1991) Selection of medical devices. Pediatric Emergency Care 7:182–183.

Office of Technology Assessment (1982) Strategies for medical technology assessment.

Okoli C, Pawlowski SD (2004) The Delphi method as a research tool: an example, design considerations and applications. Information & Management 42:15–29. doi: 10.1016/j.im.2003.11.002

Okudan GE, Tauhid S (2008) Concept selection methods – a literature review from 1980 to 2008. International Journal of Design Engineering 1:243. doi: 10.1504/IJDE.2008.023764

- Oppenheim BW (2004) Lean product development flow. *Systems Engineering* 7:352–376. doi: 10.1002/sys.20014
- O'Reilly D, Campbell K, Goeree R (2009) Clinical epidemiology. *Clinical Epidemiology: Practice and Methods* 473:1–21. doi: 10.1007/978-1-59745-385-1
- Otto KN, Wood KL (1998) Product evolution: A reverse engineering and redesign methodology. *Research in Engineering Design* 10:226–243 LA – English. doi: 10.1007/s001639870003
- Owens J, Cooper R (2001) The importance of a structured new product development (NPD) process: a methodology. *Engineering Education: Innovations in Teaching, Learning and Assessment* (Ref. No. 2001/046), IEE International Symposium on. pp 10/1–10/6
- Pammolli F, Riccaboni M, Oglialoro C, et al. (2005) Medical devices: competitiveness and impact on public health expenditure.
- Panescu D (2009) Medical device development. *Engineering in Medicine and Biology Society, 2009. EMBC 2009. Annual International Conference of the IEEE.* pp 5591–5594
- Paola FA, Walker R, Nixon LL (2010) Principles of biomedical ethics. *Medical Ethics and Humanities.* Jones & Bartlett Learning, pp 39–64
- Park T, Kim KJ (1998) Determination of an optimal set of design requirements using house of quality. *Journal of Operations Management* 16:569–581.
- Pauly M V, Burns LR (2008) Price transparency for medical devices. *Health affairs (Project Hope)* 27:1544–53. doi: 10.1377/hlthaff.27.6.1544
- Peto.co.uk (2011) Peto - Providing transparency in business to NHS markets. <http://www.peto.co.uk/>. Accessed 13 Nov 2012
- Pietzsch JB, Shluzas L a., Paté-Cornell ME, et al. (2009) Stage-gate process for the development of medical devices. *Journal of Medical Devices* 3:021004. doi: 10.1115/1.3148836
- Pitta D, Pitta E (2012) Transforming the nature and scope of new product development. *Journal of Product & Brand Management* 21:35–46. doi: 10.1108/10610421211203097
- Poon RTP (2007) Current techniques of liver transection. *HPB : the official journal of the International Hepato Pancreato Biliary Association* 9:166–73. doi: 10.1080/13651820701216182

Population Division UN (2011) World population prospects, the 2010 revision.
<http://esa.un.org/unpd/wpp/Excel-Data/population.htm>. Accessed 12 Sep 2012

Privitera MB, Design M, Murray DL (2009) Applied ergonomics: determining user needs in medical device design. Conference proceedings : . Annual International Conference of the IEEE Engineering in Medicine and Biology Society IEEE Engineering in Medicine and Biology Society Conference 2009:5606–8. doi: 10.1109/IEMBS.2009.5333781

Puccio GJ, Cabra JF, Fox JM, Cahen H (2010) Creativity on demand: Historical approaches and future trends. *Artificial Intelligence for Engineering Design, Analysis and Manufacturing* 24:153. doi: 10.1017/S0890060410000028

Raab GG, Parr DH (2006a) From medical invention to clinical practice: the reimbursement challenge facing new device procedures and technology--part 1: issues in medical device assessment. *Journal of the American College of Radiology : JACR* 3:694–702. doi: 10.1016/j.jacr.2006.02.005

Raab GG, Parr DH (2006c) From medical invention to clinical practice: the reimbursement challenge facing new device procedures and technology--part 3: payment. *Journal of the American College of Radiology : JACR* 3:842–50. doi: 10.1016/j.jacr.2006.02.027

Raab GG, Parr DH (2006b) From medical invention to clinical practice: the reimbursement challenge facing new device procedures and technology--part 2: coverage. *Journal of the American College of Radiology : JACR* 3:772–7. doi: 10.1016/j.jacr.2006.02.028

Rau HG, Duessel a P, Wurzbacher S (2008) The use of water-jet dissection in open and laparoscopic liver resection. *HPB : the official journal of the International Hepato Pancreato Biliary Association* 10:275–80. doi: 10.1080/13651820802167706

Reinhardt UE (2006) The pricing of U.S. hospital services: chaos behind a veil of secrecy. *Health affairs (Project Hope)* 25:57–69. doi: 10.1377/hlthaff.25.1.57

Ricotta JJ, Malgor RD, Oderich GS (2009) Endovascular abdominal aortic aneurysm repair: part I. *Annals of vascular surgery* 23:799–812. doi: 10.1016/j.avsg.2009.03.003

Rogalewicz V, Ujhelyiova A, Pousek L, et al. (2011) Health technology assessment and medical devices. *E-Health and Bioengineering Conference (EHB), 2011. Iași, Romani*, pp 1–6

Rogers EM (1995) *Diffusion of innovations*, 4th ed. 519.

- De Rouck S, Jacobs A, Leys M (2008) A methodology for shifting the focus of e-health support design onto user needs: a case in the homecare field. *International journal of medical informatics* 77:589–601. doi: 10.1016/j.ijmedinf.2007.11.004
- Rouse WB (2008) Health care as a complex adaptive system: Implications for design and management. *The bridge* 17–25.
- Rumbaugh J, Jacobson I, Booch G (1999) *The Unified Modeling Language reference manual*. Addison-Wesley Professional
- Salhie SM (2007) A methodology to redesign heterogeneous product portfolios as homogeneous product families. *Computer-Aided Design* 39:1065–1074. doi: 10.1016/j.cad.2007.07.005
- Santos IC, Gazelle GS, Rocha LA, Tavares JMR (2012) Medical device specificities: opportunities for a dedicated product development methodology. *Expert Review of Medical Devices* 9:299–311. doi: 10.1586/erd.12.3
- Schreyögg J, Bäuml M, Busse R (2009) Balancing adoption and affordability of medical devices in Europe. *Health policy (Amsterdam, Netherlands)* 92:218–24. doi: 10.1016/j.healthpol.2009.03.016
- Shah SGS, Robinson I (2007) Benefits of and barriers to involving users in medical device technology development and evaluation. *International journal of technology assessment in health care* 23:131–7. doi: 10.1017/S0266462307051677
- Shah SGS, Robinson I (2008) Medical device technologies: who is the user? *International Journal of Healthcare Technology and Management* 9:181. doi: 10.1504/IJHTM.2008.017372
- Shah SGS, Robinson I, AlShawi S (2009) Developing medical device technologies from users' perspectives: a theoretical framework for involving users in the development process. *International journal of technology assessment in health care* 25:514–21. doi: 10.1017/S0266462309990328
- Sharafi A, Wolfenstetter T, Wolf P, Krcmar H (2010) Comparing product development models to identify process coverage and current gaps: A literature review. *2010 IEEE International Conference on Industrial Engineering and Engineering Management*. IEEE, pp 1732–1736
- Sharif Ullah AMM, Tamaki J (2011) Analysis of Kano-model-based customer needs for product

- development. *Systems Engineering* 14:154–172. doi: 10.1002/sys.20168
- Sharma JR, Rawani AM, Barahate M (2008) Quality function deployment: a comprehensive literature review. *International Journal of Data Analysis Techniques and Strategies* 1:78. doi: 10.1504/IJDATS.2008.020024
- Sheridan N (2003) Product development as a competitive advantage. *Engineering Management* 13:38. doi: 10.1049/em:20030204
- Silverstein D, Samuel P, DeCarlo N (2008) *The innovator's toolkit: 50+ techniques for predictable and sustainable organic growth*. Wiley, Hoboken, New Jersey
- Smaling R, Weck O (2007) Assessing risks and opportunities of technology infusion in system design. *Systems engineering* 10:1–25. doi: 10.1002/sys
- Smith RP, Morrow JA (1999) Product development process modeling. *Design studies* 20:237–261.
- Smoot DC, Strong AB (2006) Product and process innovation - A review. *Journal of Advanced Materials* 38:64–79.
- Sorenson C, Tarricone R, Siebert M, Drummond M (2011) Applying health economics for policy decision making: do devices differ from drugs? *Europace* 13:ii54–ii58. doi: 10.1093/europace/eur089
- Sprague S, Quigley L, Adili A (2007) Understanding cost effectiveness: money matters? *Journal of long-term* 17:145–152.
- Stewardson A, Pittet D (2011) Ignác Semmelweis—celebrating a flawed pioneer of patient safety. *The Lancet* 378:22–23. doi: 10.1016/S0140-6736(11)61007-6
- Thirumalai S, Sinha KK (2011) Product recalls in the medical device industry: An empirical exploration of the sources and financial consequences. *Management Science* 57:376–392. doi: 10.1287/mnsc.1100.1267
- Tice JA, Helfand M, Feldman MD (2010) Clinical evidence for medical devices: regulatory processes focussing on Europe and the United States of America. 18.
- Tien JM, Goldschmidt-Clermont PJ (2009) Healthcare: A complex service system. *Journal of Systems Science and Systems Engineering* 18:257–282. doi: 10.1007/s11518-009-5108-z

- Ulrich K, Eppinger S (2011) Product design and development, 5 edition. 432.
- Unger D, Eppinger S (2011) Improving product development process design: a method for managing information flows, risks, and iterations. *Journal of Engineering Design* 22:689–699. doi: 10.1080/09544828.2010.524886
- Vallejo-Torres L, Steuten LMG, Buxton MJ, et al. (2008) Integrating health economics modeling in the product development cycle of medical devices: a Bayesian approach. *International journal of technology assessment in health care* 24:459–64. doi: 10.1017/S0266462308080604
- Volpentesta A, Rizzuti S, Muzzupappa M, Frega N (2004) Product design data modelling for review process management. *Journal of Engineering Design* 15:53–67. doi: 10.1080/0954482031000150143
- White SA, Miers D (2008) BPMN modeling and reference guide. 320.
- WHO (2012a) World: Total expenditure on health as a percentage of the gross domestic product, 2010. http://gamapserv.who.int/mapLibrary/Files/Maps/TotPercentGDP_2010.png. Accessed 6 Sep 2012
- WHO (2010) Medical devices: managing the mismatch: an outcome of the priority medical devices project. 129.
- WHO (2012b) International Classification of Diseases (ICD). <http://www.who.int/classifications/icd/en/>. Accessed 20 Jun 2012
- WHO (2003) Medical device regulations: global overview and guiding principles. WHO, Geneva
- WHO Media centre (2010) Medical devices - Fact sheet N° 346. Geneva
- Wizemann T (2010) Public health effectiveness of the FDA 510 (k) clearance process: balancing patient safety and innovation: workshop report. 140.
- Young KC, Awad NA, Johansson M, et al. (2010) Cost-effectiveness of abdominal aortic aneurysm repair based on aneurysm size. *Journal of Vascular Surgery* 51:27–32. doi: 10.1016/j.jvs.2009.08.004
- Zenios S, Makower J, Yock P, et al. (2010) Biodesign : the process of innovating medical technologies. 778.

